

Slim Remote I/O



ARIO Series CATALOG

For your safety, read and follow the considerations written in the instruction manual, other manuals and Autonics website.

The specifications, dimensions, etc. are subject to change without notice for product improvement. Some models may be discontinued without notice.

Features

- I/O supported based on industrial Ethernet / Fieldbus serial communication for Smart Factory
- Sequential multiple I/O distribution control via PLC, Industrial PC, etc.
- Coupler
 - : Supports a total of 8 different communications
 - EtherCAT, CC-Link, ProfiNet, Profibus, Ethernet/IP, DeviceNet, Modbus TCP compatible, Modbus RTU compatible
- Modules
 - : Various Input / Output Modules, Power Modules
 - Remote ABUS/ I/O power, Digital input/output (4/8 CH), Analog input/output (2/4 CH), Temperature input (4 CH)
 - Up to 64 modules can be extended (depending on communication)
- Hot-swap function
 - : Maintenance and setting can be restored automatically by replacing terminal and body during operation
- Push-in connection method
 - : Easy wire connection without tools helps reducing workload
- Expanded user convenience with DAQMaster, a device integration management program
 - Module setting, real time control and monitoring / diagnosis of input / output signal (except ARIO-C-PN/PB)
 - Product selection and placement through virtual mode, offering recommended sorting

Ordering Information

This is only for reference, the actual product does not support all combinations. For selecting the specified model, follow the Autonics website.

■ Coupler

ARIO - C - ①

① Protocol

- EC: EtherCAT
- CL: CC-Link
- PN: ProfiNet
- PB: Profibus
- EI: Ethernet/IP
- DN: DeviceNet
- MT: Modbus TCP compatible
- MR: Modbus RTU compatible

■ I/O module

ARIO - S - ① ② ③

① I/O signal

- DI: Digital input
- DO: Digital output
- AI: Analog input
- AO: Analog output

② The number of channel

- 02: 2 CH
- 04: 4 CH
- 08: 8 CH

③ I/O specifications

- N: NPN
- P: PNP
- V1: Voltage (-10 to 10 VDC=)
- V2: Voltage (0 to 10 VDC=)
- C1: Current (0 to 20 mA)
- C2: Current (4 to 20 mA)
- TC: Thermocouple
- RTD: Resistance thermometer

■ Power module

ARIO - P - ①

① Power supply

- B: Bus power
- F: I/O power
- T: Terminal power

Product Components

■ Coupler

Model	ARIO-C-EC	ARIO-C-CL	ARIO-C-PN	ARIO-C-PB
Product components	Product, instruction manual			
End module	× 1	× 1	× 1	× 1
Communication connector	-	× 1	-	-
Terminating resistance	-	× 2	-	-

Model	ARIO-C-EI	ARIO-C-DN	ARIO-C-MT	ARIO-C-MR
Product components	Product, instruction manual			
End module	× 1	× 1	× 1	× 1
Communication connector	-	× 1	-	× 1
Terminating resistance	-	× 2	-	× 2

■ Module

- Product
- Instruction manual

Software





Download the installation file and the manuals from the Autonics website.



■ DAQMaster

It is the comprehensive device management program for Autonics' products, providing parameter setting, monitoring and data management.

Specifications

■ Coupler

Model	ARIO-C-EC	ARIO-C-CL	ARIO-C-PN	ARIO-C-PB
Protocol	 EtherCAT <small>Conformance tested</small>	 CC-Link	 PROFINET <small>兼容</small>	 EtherCAT <small>兼容</small>
Transfer rate	100 Mbps	10 Mbps	100 Mbps	12 Mbps
Max. connections for modules	≤ 64	≤ 32	≤ 64	≤ 32
Memory map	1024 Byte	512 Byte	1024 Byte	488 Byte
Communication connector	RJ45 × 2	5-pin PCB	RJ45 × 2	9-pin D SUB
Setting connector	USB 2.0 type Micro B			

Model	ARIO-C-EI	ARIO-C-DN	ARIO-C-MT	ARIO-C-MR
Protocol	 EtherNet/IP	 DeviceNet	ModbusTCP compatible	ModbusRTU compatible
Transfer rate	10/100 Mbps	500 kbps	10/100 Mbps	115.2 kbps
Max. connections for modules	≤ 64	≤ 32	≤ 64	≤ 32
Memory map	1008 Byte	510 Byte	1024 Byte	512 Byte
Communication connector	RJ45 × 2	5-pin PCB	RJ45 × 2	5-pin PCB
Setting connector	USB 2.0 type Micro B			

Power supply	<ul style="list-style-type: none"> • ABUS (external consump.): 24 VDC\Rightarrow, ≤ 400 mA (≤ 9.6 W, coupler + module, ≤ 200 mA/CH, 2 CH/COM) • ABUS (internal supply): 5 VDC\Rightarrow, ≤ 960 mA (≤ 4.8 W, module) • I/O: 24 VDC\Rightarrow, ≤ 4,000 mA (≤ 96 W, ≤ 2,000 mA/CH, 2 CH/COM)
Power consumption	24 VDC \Rightarrow , standby/run: 200 mA, Max. load: 400 mA (coupler max. load)

■ Module

Type	Digital input	Digital output
Model	ARIO-S-DI□□	ARIO-S-DO□□
Channel	4 CH, 8 CH model	
I/O common	NPN, PNP model	
I/O signal level	24 VDC \Rightarrow ± 10 %	
Input voltage	Turn ON: ≥ 7 VDC \Rightarrow Turn OFF: ≤ 0.4 VDC \Rightarrow	-
Output leakage voltage	-	≤ 1.2 VDC \Rightarrow
I/O current consumption	6 mA/CH	-
Rated output current	-	500 mA/CH
Power consumption	ABUS: 5 VDC \Rightarrow , ≤ 100 mA (≤ 0.5 W)	
On delay time	≤ 0.5 ms	
Off delay time	≤ 1.5 ms	
Internal transmission speed	4 Mbps	
Insulation	I/O to inner circuit: photocoupler insulated	

Type	Analog input			
Model	ARIO-S-AI□V1	ARIO-S-AI□V2	ARIO-S-AI□C1	ARIO-S-AI□C2
Channel	2 CH, 4 CH model			
Input method	Voltage input		Current input	
Input range	-10 to 10 VDC \Rightarrow	0 to 10 VDC \Rightarrow	0 to 20 mA	4 to 20 mA
Accuracy	<ul style="list-style-type: none"> • Room temperature: PV ± 0.3% F.S. • Out of room temperature: PV ± 0.6% F.S. 			
Input impedance	Min. 1 M Ω / Max. 250 Ω			
Status indicator ON	≤ -1 V or ≥ 1 V	≥ 1 V	≥ 1 mA	≥ 4 mA
Resolution	12-bit			
Power consumption	<ul style="list-style-type: none"> • ABUS: 5 VDC\Rightarrow, ≤ 180 mA (≤ 0.9 W) • I/O: 24 VDC\Rightarrow, ≤ 15 mA (≤ 0.36 W) 			
Internal transmission speed	4 Mbps			
Insulation	<ul style="list-style-type: none"> • I/O to inner circuit: photocoupler insulated • Between channels: non-insulated 			

Type	Analog output			
Model	ARIO-S-AO□V1	ARIO-S-AO□V2	ARIO-S-AO□C1	ARIO-S-AO□C2
Channel	2 CH, 4 CH model			
Output method	Voltage output		Current output	
Output range	-10 to 10 VDC \Rightarrow	0 to 10 VDC \Rightarrow	0 to 20 mA	4 to 20 mA
Accuracy	<ul style="list-style-type: none"> • Room temperature: PV ± 0.3% F.S. • Out of room temperature: PV ± 0.6% F.S. 			
Load resistance	Min. 5 k Ω / Max. 350 Ω			
Status indicator ON	≤ -1 V or ≥ 1 V	≥ 1 V	≥ 1 mA	Always ON
Resolution	12-bit			
Power consumption	<ul style="list-style-type: none"> • ABUS: 5 VDC\Rightarrow, ≤ 180 mA (≤ 0.9 W) • I/O: 24 VDC\Rightarrow, ≤ 15 mA (≤ 0.36 W) 		<ul style="list-style-type: none"> • ABUS: 5 VDC\Rightarrow, ≤ 100 mA (≤ 0.5 W) • I/O: 24 VDC\Rightarrow, ≤ 60 mA (≤ 1.44 W) 	
Internal transmission speed	4 Mbps			
Insulation	<ul style="list-style-type: none"> • I/O to inner circuit: photocoupler insulated • Between channels: non-insulated 			

Type	Temperature input	
Model	ARIO-S-AI04TC	ARIO-S-AI04RTD
Channel	4 CH	
Input method	Voltage input	Resistance input
Input range	Refer to the 'Input type and using range'	
Display accuracy ⁰¹⁾	(PV ± 0.2% F.S. or ± 2 °C, select the higher one) ± 1-digit	(PV ± 0.2% F.S.) ± 1-digit
Status indicator ON	Temperature input within the rated range ※ No operation when the thermometer is not attached	
Resolution / Display	16-bit / 0.1 °C	
Power consumption	<ul style="list-style-type: none"> • ABUS: 5 VDC\Rightarrow, ≤ 180 mA (≤ 0.9 W) • I/O: 24 VDC\Rightarrow, ≤ 15 mA (≤ 0.36 W) 	
Internal transmission speed	4 Mbps	
Insulation	<ul style="list-style-type: none"> • I/O to inner circuit: photocoupler insulated • Between channels: non-insulated 	

01) Refer to the 'Measurement accuracy' below

• Input type and using range

Input type	Using range (°C)	Data display (dec)	
Thermocouple	K (CA)	-200.0 to 1350.0	-2000 to 13500
	J (IC)	-200.0 to 800.0	-2000 to 8000
	E (CR)	-200.0 to 800.0	-2000 to 8000
	T (CC)	-200.0 to 400.0	-2000 to 4000
	B (PR)	0.0 to 1800.0	00 to 18000
	R (PR)	0.0 to 1750.0	00 to 17500
	S (PR)	0.0 to 1750.0	00 to 17500
	N (NN)	-200.0 to 1300.0	-2000 to 13000
	C (TT) ⁰¹⁾	0.0 to 2300.0	00 to 23000
	G (TT) ⁰²⁾	0.0 to 2300.0	00 to 23000
	L (IC)	-200.0 to 900.0	-2000 to 9000
	U (CC)	-200.0 to 400.0	-2000 to 4000
	Platinel II	0.0 to 1390.0	00 to 13900
RTD	Cu50 Ω	-200.0 to 200.0	-2000 to 2000
	Cu100 Ω	-200.0 to 200.0	-2000 to 2000
	JPt50 Ω	-200.0 to 650.0	-2000 to 6500
	JPt100 Ω	-200.0 to 650.0	-2000 to 6500
	JPt1000 Ω	-200.0 to 500.0	-2000 to 5000
	DPt50 Ω	-200.0 to 650.0	-2000 to 6500
	DPt100 Ω	-200.0 to 650.0	-2000 to 6500
	DPt1000 Ω	-200.0 to 500.0	-2000 to 5000
	Nickel100 Ω	-50.0 to 200.0	-500 to 2000
	Nickel120 Ω	-50.0 to 200.0	-500 to 2000
Nickel1000 Ω	-50.0 to 200.0	-500 to 2000	

01) C(TT): Same as existing W5(TT) type sensor

02) G(TT): Same as existing W(TT) type sensor

• Measurement accuracy

Input type	Using temperature	Measurement accuracy
Thermo-couple	At room temperature (23 ± 5 °C)	<ul style="list-style-type: none"> • Thermocouple K, J, T, N, E below -100 °C and L, U, PLII: (PV ± 4 °C) ± 1-digit • Thermocouple R, S below ± 200 °C: ± 4 °C ± 1-digit • Thermocouple B below 400 °C: no accuracy standards • RTD Cu50 Ω, Cu100 Ω, Ni100 Ω, Ni120 Ω, Ni1000 Ω: (PV ± 2 °C) ± 1-digit
	Out of room temperature range	<ul style="list-style-type: none"> • Thermocouple: (PV ± 0.5% F.S or ± 7 °C higher one) ± 1-digit • RTD: (PV ± 0.5% F.S or ± 3 °C higher one) ± 1-digit

Type	ABUS power supply		
Model	ARIO-P-B		
Power supply	• ABUS (external consump.): 24 VDC≐, ≤ 320 mA (≤ 7.5 W, ≤ 160 mA/CH, 2 CH/COM)		
	• ABUS (internal supply): 5 VDC≐, ≤ 1,500 mA (≤ 7.5 W)		
Type	I/O power supply		
Model	ARIO-P-F1	ARIO-P-F2	ARIO-P-T1 ARIO-P-T2
Input	Voltage	24 VDC≐ 10% (≤ 48 W)	
	Max. current	2,000 mA/CH, 2 CH/COM	
Output	Voltage	24 VDC≐ 10% (≤ 48 W)	
	Max. current	2,000 mA/CH, 6 CH/COM	

Common specifications

Insulation resistance	≥ 100 MΩ (500 VDC≐ megger)
Dielectric strength	1000 VAC~ 50/60 Hz for 1 min
Noise immunity	500 VDC≐ the square wave noise (pulse width: 1 μs) by the noise simulator
Vibration	0.7 mm double amplitude at frequency of 10 to 55 Hz (for 1 min) in each X, Y, Z direction for 1 hour
Vibration (malfunction)	0.5 mm double amplitude at frequency of 10 to 55 Hz (for 1 min) in each X, Y, Z direction for 10 min
Shock	300 m/s ² (≈ 30 G) in each X, Y, Z direction for 3 times
Shock (malfunction)	100 m/s ² (≈ 10 G) in each X, Y, Z direction for 3 times
Ambient temperature	-10 to 55 °C, storage: -25 to 70 °C (no freezing or condensation)
Ambient humidity	35 to 85 %RH, storage: 35 to 85 %RH (no freezing or condensation)
Protection rating	IP20 (IEC standard)
Material	Terminal: PA6, body: MPPO, base: PA6, POM
Installation method	DIN rail mounting
Approval	CE, RoHS, REACH
Unit weight (packaged)	• Coupler: ≈ 165 g (≈ 265 g) • Module: ≈ 75 g (≈ 108 g)

Dimensions

- Unit: mm, For the detailed drawings, follow the Autonics website.
- It may differ depending on the model.

Coupler

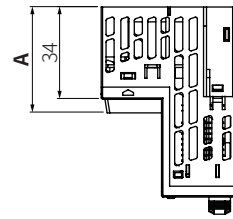

Model	A
ARIO-C-EC/EI/PN/MT	39
ARIO-C-DN/CL/MR	36.2
ARIO-C-PB	38.2

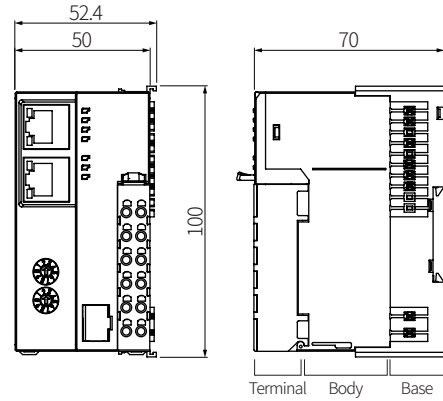

• End module

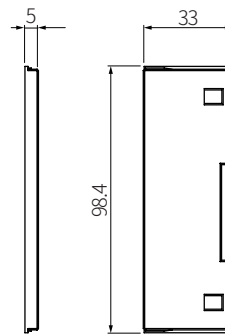

Module

A	Status indicator
B	Channel indicator

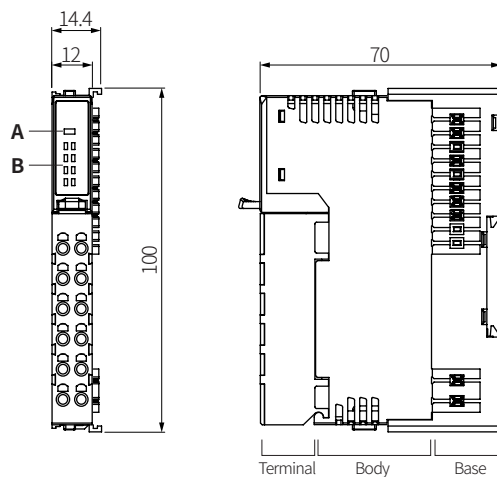



Unit Descriptions

- It may differ depending on the model.
- Refer to the 'Dimensions' in case of the module.

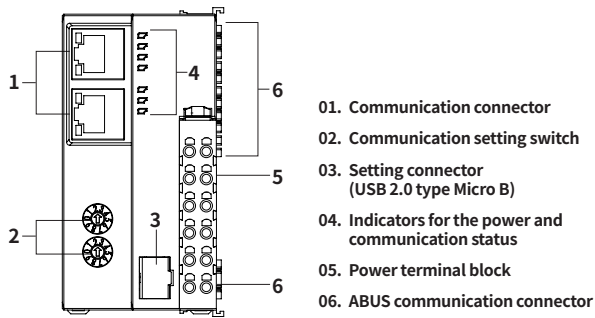
■ Coupler



01. Communication connector

ARIO-C-EC/PN/EI/MT	ARIO-C-PB	ARIO-C-CL/DN/MR
RJ-45 connectors: 2	D SUB-9 Pin	5-pin PCB Connector
		

02. Communication setting switch

ARIO-C-EC	ARIO-C-CL/DN	The others
None	Decimal rotary switches: 3 (communication speed, address ($\times 10, \times 1$))	Hexagonal rotary switches: 2 (address ($\times 16, \times 1$))

Sold Separately

- Terminal and base of the coupler
- Terminal, body, and base of the module