

W 7.2 mm Photoelectric Sensors



BTS Series CATALOG

For your safety, read and follow the considerations written in the instruction manual, other manuals and Autonics website.

The specifications, dimensions, etc. are subject to change without notice for product improvement. Some models may be discontinued without notice.

Features

- W 7.2 mm Photoelectric Sensors
 - W 7.2 × H 18.6 × L 9.5 mm (Through-beam type)
 - W 7.2 × H 24.6 × L 10.8 mm (Retroreflective, convergent reflective type)
- Detection methods and minimum target size
 - Through-beam type (BTS1M): Ø 2 mm
 - Retroreflective type (BTS200): Ø 2 mm (sensing distance: 100 mm)
 - Convergent reflective type (BTS15/BTS30): Ø 0.15 mm (sensing distance: 10 mm)
- Maximum sensing distance: 1 m (Through-beam type)
- Operation indicator (red) and stability indicator (green) show operation status
- Stainless steel (SUS304) mounting brackets
- IP67 protection rating (IEC standard)

Ordering Information

This is only for reference, the actual product does not support all combinations. For selecting the specified model, follow the Autonics website.

BTS ① - ② **D T** ③ - ④

① Sensing distance

Number: Sensing distance (unit: mm)
Number+M: Sensing distance (unit: m)

③ Operation mode

L: Light ON
D: Dark ON

② Sensing type

T: Through-beam
M: Retroreflective
L: Convergent reflective

④ Control output

No mark: NPN open collector output
P: PNP open collector output

Product Components

Sensing type	Through-beam	Retroreflective	Convergent reflective
Product components	Product, instruction manual		
Reflector	-	MS-6	-
Bracket A	× 2	× 1	× 1
Sub bracket	× 2	× 1	× 1
M2 bolt	× 4	× 2	× 2

Specifications

Model	BTS1M-TDT□-□	BTS200-MDT□-□	BTS□-LDT□-□
Sensing type	Through-beam	Retroreflective	Convergent reflective
Sensing distance	1 m	10 to 200 mm ⁰¹⁾	5 to 15 mm ⁰²⁾ 5 to 30 mm ⁰²⁾
Sensing target	Opaque materials	≥ Ø 27 mm Opaque materials	Opaque materials, translucent materials
Min. sensing target	≥ Ø 2 mm	≥ Ø 2 mm ⁰³⁾	≥ Ø 0.15 mm ⁰⁴⁾
Hysteresis	-	-	≤ 15% of sensing distance
Response time	≤ 1 ms		
Light source	Red		
Peak emission wavelength	650 nm		
Operation mode	Light ON mode / Dark ON mode model		
Indicator	Operation indicator (red), stability indicator (green)		
Approval	CE EAC	CE EAC	CE EAC
Unit weight (packaged)	≈ 40 g (≈ 65 g)	≈ 25 g (≈ 45 g)	≈ 25 g (≈ 45 g)

01) Reflector (MS-6)

02) Non-glossy white paper 50 × 50 mm

03) Sensing distance 100 mm

04) Sensing distance 10 mm

Power supply	12-24 VDC± ± 10% (ripple P-P: ≤ 10%)
Current consumption	It depends on the sensing type
Through-beam	Emitter: ≤ 20 mA, receiver: ≤ 20 mA
Reflective	≤ 20 mA
Control output	NPN open collector output / PNP open collector output model
Load voltage	≤ 26.4 VDC±
Load current	≤ 50 mA
Residual voltage	NPN: ≤ 1 VDC±, PNP: ≤ 2 VDC±
Protection circuit	Reverse power protection circuit, output short overcurrent protection circuit
Insulation resistance	≥ 20 MΩ (500 VDC± megger)
Noise immunity	±240 VDC± the square wave noise (pulse width: 1 μs) by the noise simulator
Dielectric strength	1,000 VAC ~ 50/60 Hz for 1 min
Vibration	1.5 mm double amplitude at frequency of 10 to 55 Hz (for 1 min) in each X, Y, Z direction for 2 hours
Shock	500 m/s ² (≈ 50 G) in each X, Y, Z direction for 3 times
Ambient illuminance (receiver)	Sunlight: ≤ 10,000 lx, incandescent lamp: ≤ 3,000 lx
Ambient temperature	-20 to 55 °C, storage: -30 to 70 °C (no freezing or condensation)
Ambient humidity	35 to 85 %RH, storage: 35 to 85 %RH (no freezing or condensation)
Protection rating	IP67 (IEC standard)
Connection	Cable type
Cable spec.	Ø 2.5 mm, 3-wire (emitter: 2-wire), 2 m
Wire spec.	AWG 28 (0.08 mm, 19-core), insulator outer diameter: Ø 0.9 mm
Material	Case: PBT, sensing part: PMMA, bracket: SUS304, bolt: SWCH10A

Dimensions

- Unit: mm, For the detailed drawings, follow the Autonics website.

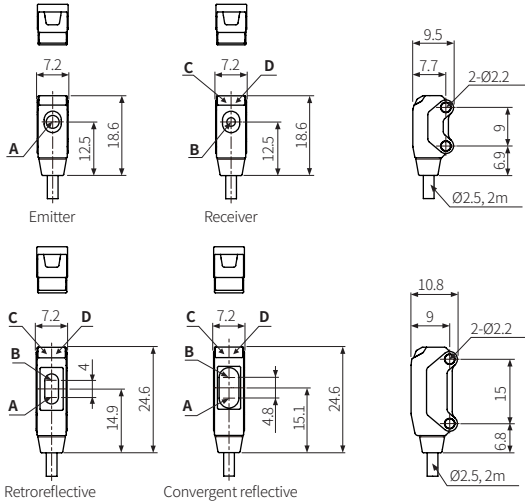

A	Optical axis of emitter	C	Operation indicator (red)
B	Optical axis of receiver	D	Stability indicator (green)

Reflector (MS-6)

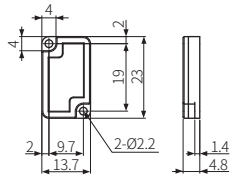

Bracket A

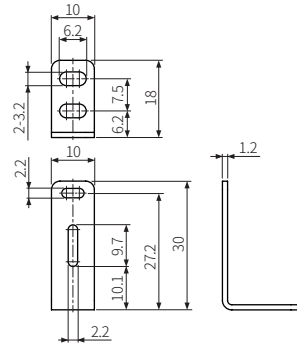

Sub-bracket

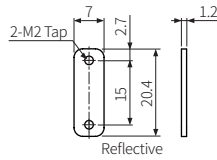
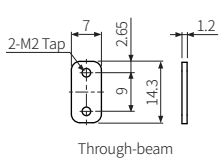

Sold Separately

- Reflector: MS Series
- Retroreflective tape: MST Series
- Bracket B
- Slit for through-beam type: BTS1M-ST (sticker), BTS1M-ST-T (SUS material)

Sold Separately: Bracket B

- Unit: mm, For the detailed drawings, follow the Autonics website.

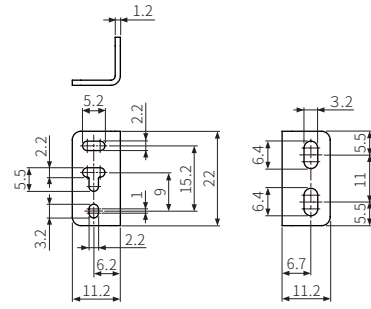

Sold Separately: Slit for Through-beam Type

BTS1M-ST (sticker)

- Unit: mm

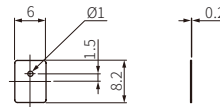

- Be sure to attach for the emitter of through-beam type (packaged unit: 4 pieces).
- Gently wipe the dirt on the lens of the sensor before using it.
- After attaching the slit, remove the front protection film.

Slit Ø	Applied condition		Min. sensing target	Max. sensing distance
	Emitter	Receiver		
Ø 1 mm	○	-	≥ Ø 1.6 mm Opaque materials	500 mm

BTS1M-ST-T (SUS Material)

- Unit: mm

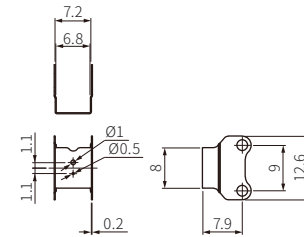

- This slit is available for the emitter and receiver of through-beam type (packaged unit: 2 pieces)
- Ø of slit is depending on the installation direction.
- After covering the sensor with the slit, fix them with the bolts and sub-bracket.

Slit Ø	Applied condition		Min. sensing target	Max. sensing distance	Feature data
	Emitter	Receiver			
Ø 1 mm	○	-	≥ Ø 1.6 mm Opaque materials	500 mm	①
	-	○	≥ Ø 1.2 mm Opaque materials	300 mm	②
Ø 0.5 mm	○	-	≥ Ø 1.2 mm Opaque materials	300 mm	③
	-	○	≥ Ø 0.8 mm Opaque materials	100 mm	④

Feature data ①

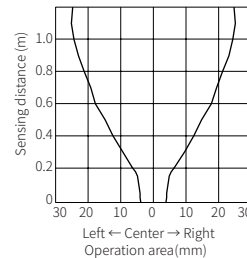

Feature data ②

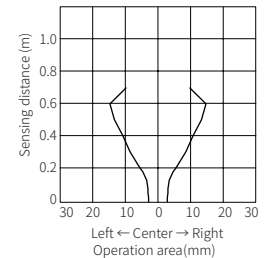

Feature data ③

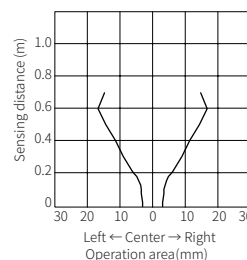

Feature data ④

