

Industrial Automation Headquarters

Delta Electronics, Inc.
Taoyuan Technology Center
No.18, Xinglong Rd., Taoyuan District,
Taoyuan City 33068, Taiwan
TEL: 886-3-362-6301 / FAX: 886-3-371-6301

Asia

Delta Electronics (Shanghai) Co., Ltd.
No.182 Minyu Rd., Pudong Shanghai, P.R.C.
Post code : 201209
TEL: 86-21-6872-3988 / FAX: 86-21-6872-3996
Customer Service: 400-820-9595

Delta Electronics (Japan), Inc.
Tokyo Office
Industrial Automation Sales Department
2-1-14 Shibadaimon, Minato-ku
Tokyo, Japan 105-0012
TEL: 81-3-5733-1155 / FAX: 81-3-5733-1255

Delta Electronics (Korea), Inc.
Seoul Office
1511, 219, Gasan Digital 1-Ro., Geumcheon-gu,
Seoul, 08501 South Korea
TEL: 82-2-515-5305 / FAX: 82-2-515-5302

Delta Energy Systems (Singapore) Pte Ltd.
4 Kaki Bukit Avenue 1, #05-04, Singapore 417939
TEL: 65-6747-5155 / FAX: 65-6744-9228

Delta Electronics (India) Pvt. Ltd.
Plot No.43, Sector 35, HSIIDC Gurgaon,
PIN 122001, Haryana, India
TEL: 91-124-4874900 / FAX : 91-124-4874945

Delta Electronics (Thailand) PCL.
909 Soi 9, Moo 4, Bangpoo Industrial Estate (E.P.Z),
Pattana 1 Rd., T.Phraksa, A.Muang,
Samutprakarn 10280, Thailand
TEL: 66-2709-2800 / FAX : 662-709-2827

Delta Electronics (Australia) Pty Ltd.
Unit 20-21/45 Normanby Rd., Notting Hill Vic 3168, Australia
TEL: 61-3-9543-3720

Americas

Delta Electronics (Americas) Ltd.
Raleigh Office
P.O. Box 12173, 5101 Davis Drive,
Research Triangle Park, NC 27709, U.S.A.
TEL: 1-919-767-3813 / FAX: 1-919-767-3969

Delta Greentech (Brasil) S/A
São Paulo Office
Rua Itapeva, 26 – 3º Andar - Bela Vista
CEP: 01332-000 – São Paulo – SP - Brasil
TEL: 55-11-3530-8643 / 55-11-3530-8640

Delta Electronics International Mexico S.A. de C.V.
Mexico Office
Gustavo Baz No. 309 Edificio E PB 103
Colonia La Loma, CP 54060
Tlalnepantla, Estado de México
TEL: 52-55-3603-9200

EMEA

Headquarters: Delta Electronics (Netherlands) B.V.
Sales: Sales.IA.EMEA@deltaww.com
Marketing: Marketing.IA.EMEA@deltaww.com
Technical Support: iatechnicalsupport@deltaww.com
Customer Support: Customer-Support@deltaww.com
Service: Service.IA.emea@deltaww.com
TEL: +31(0)40 800 3900

BENELUX: Delta Electronics (Netherlands) B.V.
De Witbogt 20, 5652 AG Eindhoven, The Netherlands
Mail: Sales.IA.Benelux@deltaww.com
TEL: +31(0)40 800 3900

DACH: Delta Electronics (Netherlands) B.V.
Coesterweg 45, D-59494 Soest, Germany
Mail: Sales.IA.DACH@deltaww.com
TEL: +49(0)2921 987 0

France: Delta Electronics (France) S.A.
ZI du bois Challand 2, 15 rue des Pyrénées,
Lisses, 91090 Evry Cedex, France
Mail: Sales.IA.FR@deltaww.com
TEL: +33(0)1 69 77 82 60

Iberia: Delta Electronics Solutions (Spain) S.L.U
Ctra. De Villaverde a Vallecas, 265 1º Dcha Ed.
Hormigueras – P.I. de Vallecas 28031 Madrid
TEL: +34(0)91 223 74 20

Carrer Llacuna 166, 08018 Barcelona, Spain
Mail: Sales.IA.Iberia@deltaww.com

Italy: Delta Electronics (Italy) S.r.l.
Via Meda 2–22060 Novedrate(CO)
Piazza Grazioli 18 00186 Roma Italy
Mail: Sales.IA.Italy@deltaww.com
TEL: +39 039 8900365

Russia: Delta Energy System LLC
Vereyskaya Plaza II, office 112 Vereyskaya str.
17 121357 Moscow Russia
Mail: Sales.IA.RU@deltaww.com
TEL: +7 495 644 3240

Turkey: Delta Greentech Elektronik San. Ltd. Sti. (Turkey)
Şerifali Mah. Hendem Cad. Kule Sok. No:16-A
34775 Ümraniye – İstanbul
Mail: Sales.IA.Turkey@deltaww.com
TEL: + 90 216 499 9910

GCC: Delta Energy Systems AG (Dubai BR)
P.O. Box 185668, Gate 7, 3rd Floor, Hamarain Centre
Dubai, United Arab Emirates
Mail: Sales.IA.MEA@deltaww.com
TEL: +971(0)4 2690148

Egypt + North Africa: Delta Electronics
Unit 318, 3rd Floor, Trivium Business Complex, North 90 street,
New Cairo, Cairo, Egypt
Mail: Sales.IA.MEA@deltaww.com

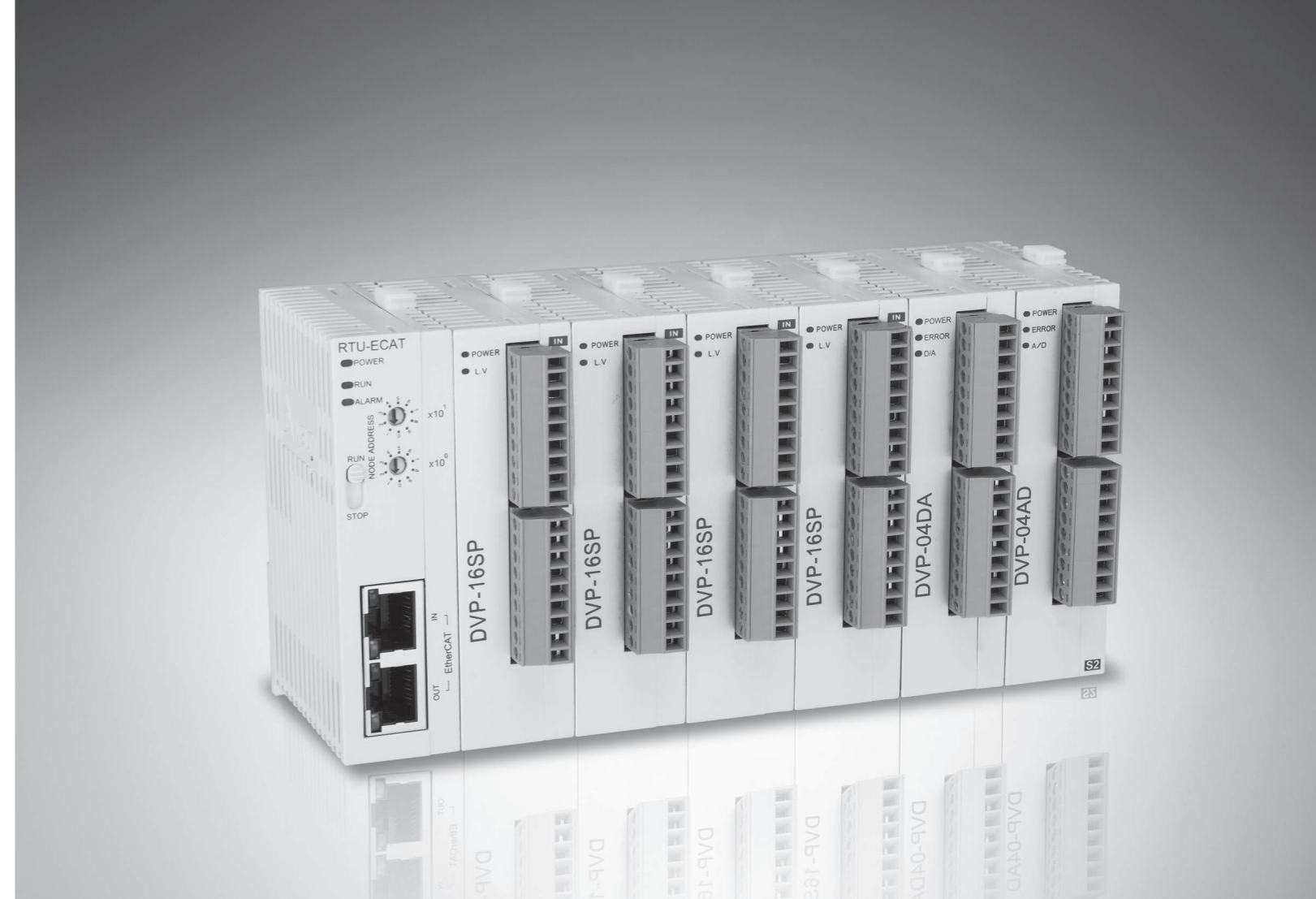

RTU-ECAT EtherCAT Remote IO Communication Module Operation Manual

RTU-ECAT Operation Manual

Table of Contents

Chapter 1 Preface	1-1
1.1 Explanation of Symbols in This Manual	1-2
1.2 Revision History	1-2
Chapter 2 Overview	2-1
2.1 Characteristics	2-2
2.2 Specifications	2-2
2.3 Extension Modules Connectable to RTU-ECAT	2-3
Chapter 3 Profile and Parts	3-1
3.1 Profile and Dimension	3-2
3.2 Parts	3-2
3.3 EtherCAT Port	3-3
3.4 RUN/STOP Switch	3-3
3.5 Address Switches	3-3
3.6 Extended IO Interface	3-4
Chapter 4 Installing and Wiring	4-1
4.1 Installing RTU-ECAT and DVP-S Extension Modules	4-2
4.2 Installing RTU-ECAT and DVP-S Modules on DIN Rail	4-2
4.3 Connecting to EtherCAT Port	4-3
4.4 Wiring	4-3
4.4.1 Power Input	4-3
4.4.2 Ground	4-5
Chapter 5 Configuring RTU-ECAT	5-1
5.1 Terms	5-2
5.2 Introduction to the Software Interfaces	5-3
5.2.1 Main Interface for RTU Configuration	5-3
5.2.2 DC Interface	5-3

5.2.3	Right-side Configuration of RTU-ECAT	5-4
5.2.4	Data Exchange Configuration Interface of Special Modules	5-5
Chapter 6	Introduction of Parameters	6-1
6.1	Parameters for Right-side Special Modules	6-2
6.2	Parameters for Connection Status of Right-Side Modules	6-5
6.3	Control Word and Status Indication Parameters	6-6
6.3.1	Control Word Parameter.....	6-6
6.3.2	Status Indication	6-7
Chapter 7	Application Examples	7-1
7.1	Using Delta AX8 Series CPU with RTU-ECAT	7-3
7.2	Using TwinCAT3 with RTU-ECAT	7-13
7.2.1	Configuring the Network via TwinCAT3.....	7-13
7.2.2	Controlling RTU-ECAT's Right-side Modules via PLC	7-24
7.3	Using OMRON NJ301 with RTU-ECAT	7-27
Chapter 8	Error Diagnosis and Trouble-shooting	8-1
8.1	LED Indicator Diagnosis	8-2
8.2	Status Indication Diagnosis.....	8-3
Appendix A	List of Accessories	A-1
A.1	Accessories for EtherCAT Communication	A-2

Chapter 1 Preface

Table of Contents

1.1 Explanation of Symbols in This Manual 1-2
1.2 Revision History..... 1-2

1



Caution

- This manual provides an introduction to product functions, specifications, installation, basic operations and settings.
- This product is an OPEN TYPE device and therefore should be installed in an enclosure free of airborne dust, humidity, electric shock and vibration. The enclosure should prevent non-maintenance staff from operating the device (e.g. key or specific tools are required for operating the enclosure) in case that danger and damage on the device may occur.
- Be sure to read the manual carefully and follow the instructions so as to avoid injuries to personnel and damage to products.

1.1 Explanation of Symbols in This Manual

- **Precautions before operation**

Before operation, please read relevant safety instructions carefully so as to prevent an injury to personnel and damage to products.

 Danger	indicates the highly potential hazards. Severe personal injury or even death will result if you do not follow the instructions.
 Warning	indicates the potential hazards. Minor personal injury or even death may result if you do not follow the instructions.
 Caution	indicates much attention should be paid. A bad accident can occur if you do not follow the instructions.

1.2 Revision History

Version	Revision	Release Date
1 st	The first version was published.	April 10, 2020

Chapter 2 Overview

Table of Contents

2.1 Characteristics.....	2-2
2.2 Specifications	2-2
2.3 Extension Modules Connectable to RTU-ECAT	2-3

2

1. Thank you for choosing Delta RTU-ECAT. To ensure correct installation and operation of RTU-ECAT, please read this manual carefully before use.
2. This manual only provides introductory information on RTU-ECAT. For more detailed information on EtherCAT protocol, please refer to relevant references or literatures.
3. RTU-ECAT is defined as an EtherCAT slave and DVP-S series DI/DO modules and special modules can be connected on its right side.
4. Refer to **DVP-PLC Application Manual: Special Modules** for more details on how to use DVP-S series special modules.

2.1 Characteristics

- Compliant with the EtherCAT protocol, RTU-ECAT supports PDO, SDO and other services in the COE protocol.
- Supports Distributed Clock SYNC and SyncManagers SYNC.
- On its right side, RTU-ECAT connects DVP-S series right-side modules with maximum 128 digital input points and 128 digital output points as well as maximum 8 special modules such as analog modules, temperature modules, pulse modules and etc.
- Maximum 14 DVP-S series digital modules and special modules in total can be connected to the right side of RTU-ECAT.
- Users can select that the output values of right-side special modules and digital output point values of digital modules keep the same as they are before disconnection or change to zero when RTU-EtherCAT is disconnected from the master.

2.2 Specifications

■ Electrical specification

Item	Specification
Power voltage	24 VDC (-15% ~ 20%)
Consumption power	1.8 W
Isolation voltage	500 V

■ EtherCAT specification

Item	Specification
Communication protocol	EtherCAT Protocol
Supported service	CoE (PDO, SDO)
Physical layer	100BASE-TX
Baud rate	100Mbps
Transmission medium	Cat 5 or above shielded cable
Transmission distance	100m
Topology Structure	Linear topology

■ Environment

Item	Specification
Noise Immunity	ESD (IEC 61131-2, IEC 61000-4-2) : 8KV Air Discharge, 6KV Contact Discharge EFT (IEC 61131-2, IEC 61000-4-4) : Power Line: 2KV, Digital I/O: 1KV Communication I/O: 2KV Damped-Oscillatory Wave: Power Line: 1KV, Digital I/O: 1KV RS(IEC 61131-2, IEC 61000-4-3): 80MHz ~ 1000MHz, 10V/m; 1400MHz ~ 6000MHz, 3V/m
Operation	0°C ~ 55°C (temperature), 50 ~ 95% (humidity), pollution degree 2
Storage	-25°C ~ 70°C (temperature), 5 ~ 95% (humidity)
Vibration/shock resistance	Standard: IEC 61131-2, IEC 68-2-6 (TEST Fc)/IEC 61131-2 & IEC 68-2-27 (TEST Ea)
Safety	Conforms to IEC 61131-2, UL 61010-1, UL 61010-2-201
Barometric pressure-altitude	Operating: 1080~795hPa (-1000~2000m) Storage: 1080~660hPa (-1000~3500m)
Weight	84g

2.3 Extension Modules Connectable to RTU-ECAT

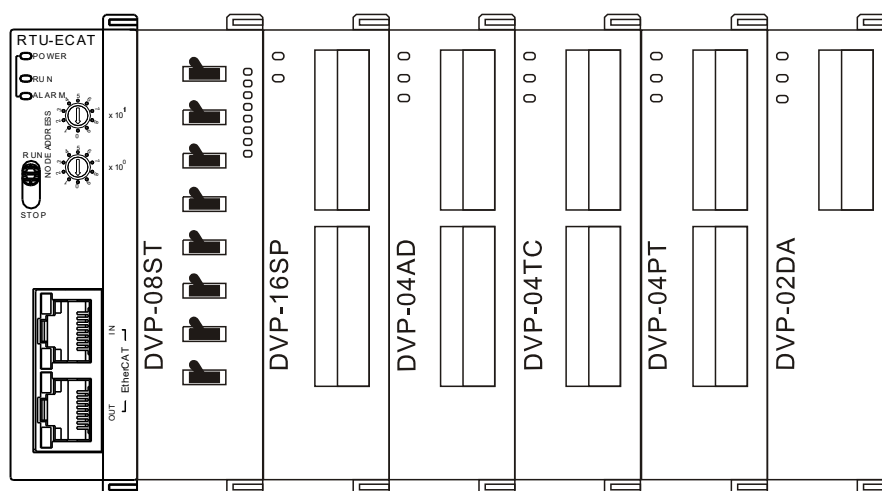

■ Digital modules connectable to RTU-ECAT

DI/DO module (Model name)	Default I/O mapping data (EtherCAT master → RTU-ECAT)	Default I/O mapping data (RTU-ECAT → EtherCAT master)
DVP08SM11N	N/A	8 bits
DVP08SM10N	N/A	8 bits
DVP16SM11N	N/A	16 bits

DI/DO module (Model name)	Default I/O mapping data (EtherCAT master → RTU-ECAT)	Default I/O mapping data (RTU-ECAT → EtherCAT master)
DVP06SN11R	8 bits	N/A
DVP08SN11R/T	8 bits	N/A
DVP08SN11TS	8 bits	N/A
DVP16SN11T	16 bits	N/A
DVP16SN11TS	16 bits	N/A
DVP08SP11R/T	8 bits	8 bits
DVP08SP11TS	8 bits	8 bits
DVP16SP11R/T	8 bits	8 bits
DVP16SP11TS	8 bits	8 bits
DVP32SM11N	N/A	32 bits
DVP32SN11TN	32 bits	N/A
DVP08ST11N	N/A	8 bits

■ Special modules connectable to RTU-ECAT

Special module (Model name)	Default IO mapping data (EtherCAT master → RTU-ECAT)		Default IO mapping data (RTU-ECAT → EtherCAT master)	
	Start CR	Length (words)	Start CR	Length (words)
	DVP02DA-S	CR10	2	N/A
DVP04DA-S	CR6	4	N/A	N/A
DVP04DA-S2	CR6	4	N/A	N/A
DVP04AD-S	N/A	N/A	CR12	4
DVP04AD-S2	N/A	N/A	CR12	4
DVP06AD-S	N/A	N/A	CR12	6
DVP04TC-S	N/A	N/A	CR14	4
DVP04PT-S	N/A	N/A	CR18	4
DVP06PT-S	N/A	N/A	CR18	6
DVP06XA-S	CR10	2	CR12	4
DVP06XA-S2	CR10	2	CR12	4
DVP01PU-S	CR42	4	CR33	4
DVP02TUL-S	CR4	2	CR2	2
DVP02TUR-S	CR4	2	CR2	2
DVP02TUN-S	CR4	2	CR2	2

Note:

When special modules are connected to RTU-ECAT, the start one of CRs for data upload and download and the length of data to be uploaded and downloaded can be set up via the EtherCAT network configuration tool.

MEMO

2

Chapter 3 Profile and Parts

Table of Contents

3.1 Profile and Dimension.....	3-2
3.2 Parts.....	3-2
3.3 EtherCAT Port	3-3
3.4 RUN/STOP Switch.....	3-3
3.5 Address Switches	3-3
3.6 Extended IO Interface	3-4

3.1 Profile and Dimension

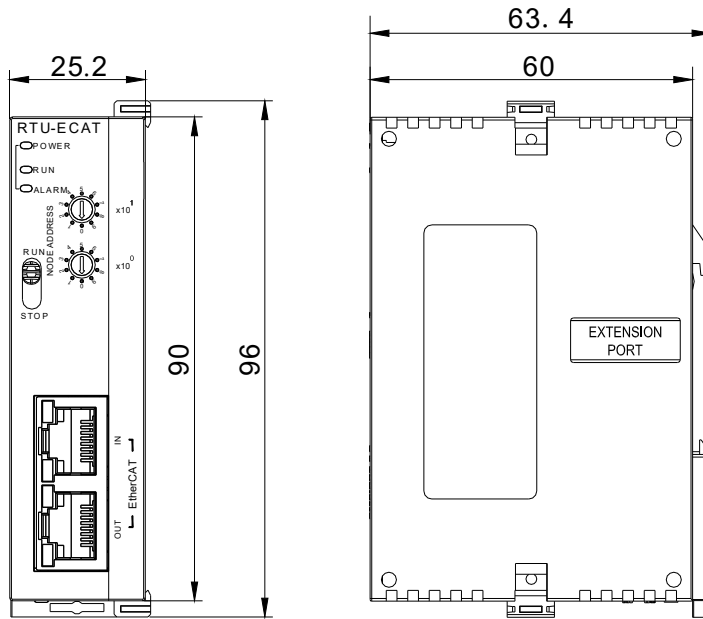

Unit: mm

3.2 Parts

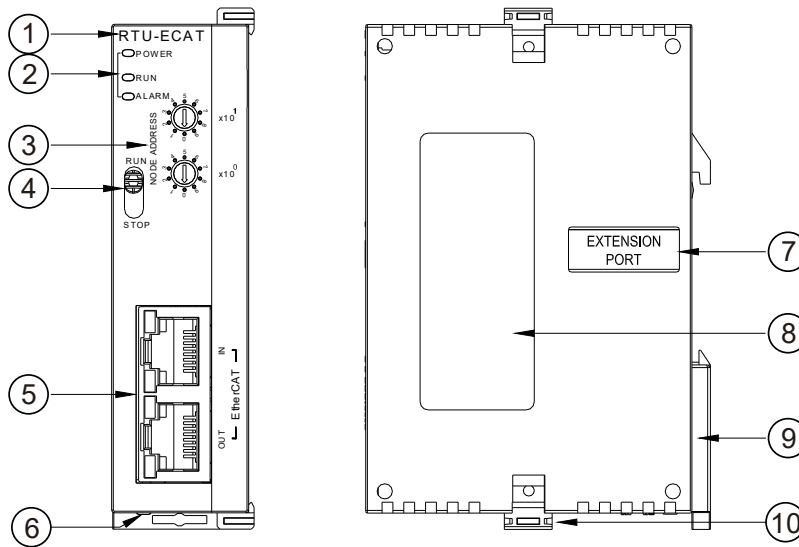

1. Model Name	6. 24V DC power port
2. State indicators	7. Right-side extension module port
3. Address switch	8. Nameplate
4. RUN/STOP switch	9. DIN rail clip
5. EtherCAT port	10. Extension module fixing clip

3.3 EtherCAT Port

EtherCAT port is used for the EtherCAT communication.

See the following table for the definitions of pins.

PIN	Signal	Description
1	Tx+	Positive pole for transmitting data
2	Tx-	Negative pole for transmitting data
3	Rx+	Positive pole for receiving data
4	Reserved	Reserved
5	Reserved	Reserved
6	Rx-	Negative pole for receiving data
7	Reserved	Reserved
8	Reserved	Reserved

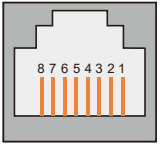

EtherCAT

3.4 RUN/STOP Switch

RUN/STOP switch	Description
STOP → RUN	<ol style="list-style-type: none"> To re-detect the number of extension modules and digital points. To read/write the data in the extension module.
RUN → STOP	To stop reading/writing the data in the extension module.

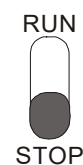

3.5 Address Switches

The switches are used for setting up the node address of RTU-ECAT on EtherCAT network.

Switch setting	Description
0 ~ 99	EtherCAT node address

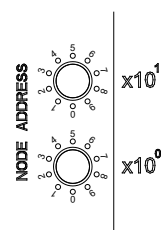

Example:

If you need to set the node address of RTU-ECAT to 26, simply switch the corresponding switch of $x10^1$ to 2 and the corresponding switch of $x10^0$ to 6.

Notes:

- ✓ Please set up the node address when the power is switched off. After the setup is completed, re-power RTU-ECAT.
- ✓ When RTU-ECAT is operating, changing the setting of the node address will be invalid.
- ✓ Use the slotted screwdriver to rotate the switch carefully in case the switch is scratched.

3.6 Extended IO Interface

The interface is used for connecting Delta DVP-S series DI/DO extension modules and special modules.

Chapter 4 Installing and Wiring

Table of Contents

4.1 Installing RTU-ECAT and DVP-S Extension Modules.....	4-2
4.2 Installing RTU-ECAT and DVP-S Modules on DIN Rail	4-2
4.3 Connecting to EtherCAT Port	4-3
4.4 Wiring.....	4-3
4.4.1 Power Input.....	4-3
4.4.2 Ground	4-5

4.1 Installing RTU-ECAT and DVP-S Extension Modules

- Open the fixing clips on the top and bottom of RTU-ECAT, aim the extension module at the guiding holes and keep them met.
- Press the fixing clips on the top and bottom of RTU-ECAT to fix extension modules and ensure that the connection is fine.

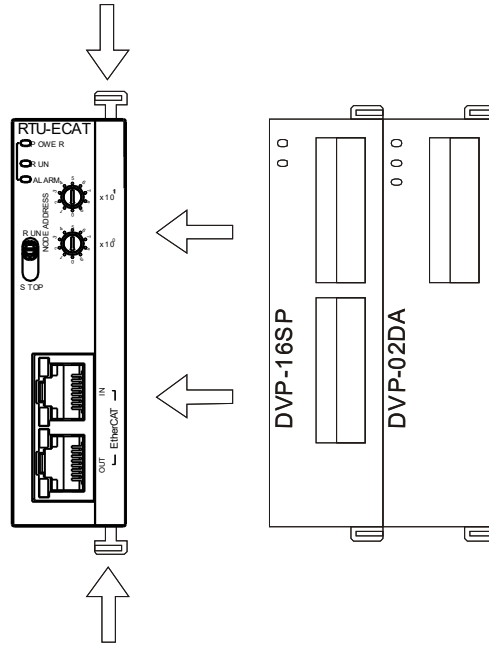

4

4.2 Installing RTU-ECAT and DVP-S Modules on DIN Rail

- Use the 35mm standard DIN rail.
- Open the DIN rail clips of RTU-ECAT and extension modules. Insert RTU-ECAT and extension modules into the DIN rail.
- Press the DIN rail clips of RTU-ECAT and extension modules to fix them on the DIN rail, as shown below.

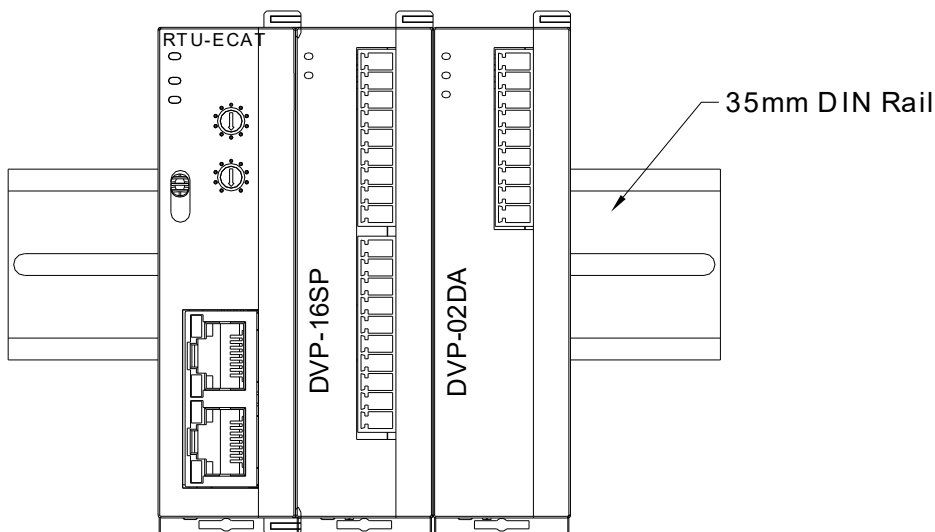

4.3 Connecting to EtherCAT Port

- There is a strict network topology requirement for the EtherCAT network. The network must follow the rule that the input port of the next servo should be connected to the output port of the previous servo.
- Please use Delta cables as EtherCAT cables. For specifications of Delta cables, refer to Appendix 1.

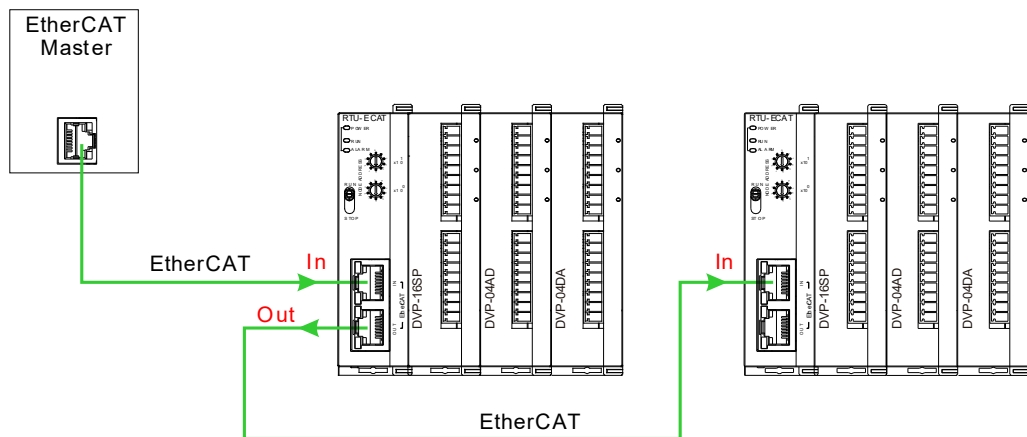

4.4 Wiring

4.5 Power Input

The power input of RTU-ECAT is 24V DC. Please notice the following points during use.

⚠ Warning

- Connect the supply power to the two terminals, 24V and 0V and the grounding terminal to the earth. Be cautious that the RTU-ECAT device may be damaged if the positive and negative polarities of the supply power are connected reversely.
- Please be sure to use certified power supply with SELV output or certified power supply providing double insulation evaluated by UL60950, or UL61010-1 and UL61010-2-201 standards
- The diameter of the power wire must be between 12 and 28AWG and the rated temperature should be greater than 70°C. The power terminal block plug wiring torque is 4.5 in-lbs.
- The cables of the AC power 110V, 220V and DC power 24V must be twisted and connected to the module as short as possible in length.
- Do not combine the AC 110V, 220V, and DC 24V cables with the main circuit and I/O signal cables together and please keep them away from each other. If the space permits, it's recommended to separate these lines by more than 100mm.

RTU-ECAT Safety Circuit Wiring

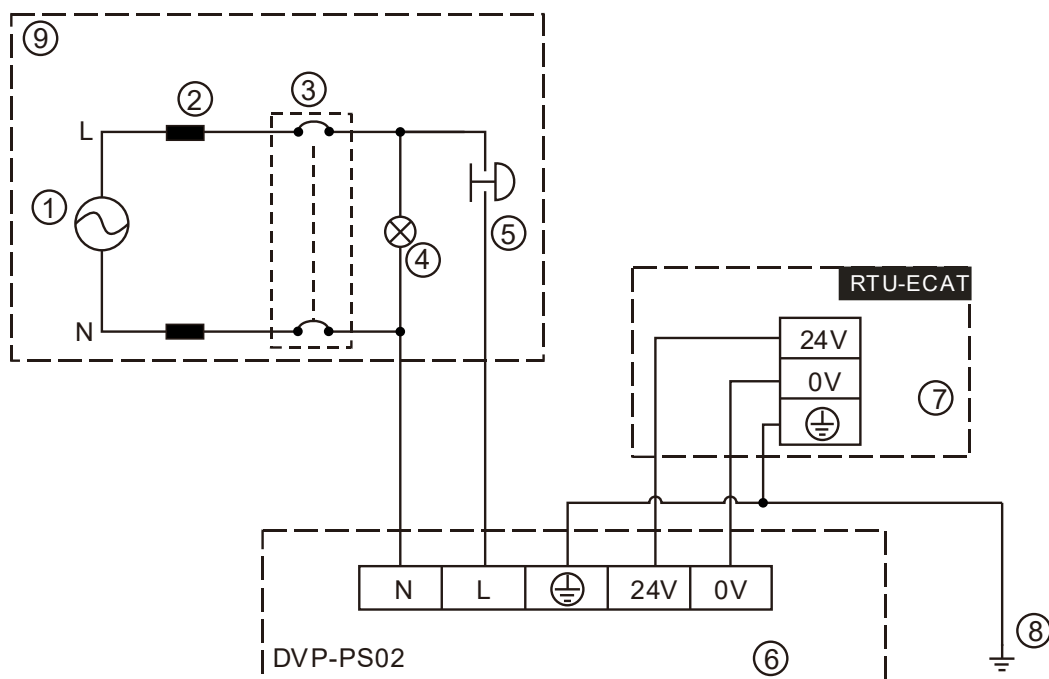

4

①	AC power supply: 100 ~ 240VAC; 50/60Hz.
②	Power supply circuit protection fuse
③	System circuit isolation device: The electromagnetic contactor, relay and other switch can be used as the isolation device to prevent the system from becoming unstable when the power supply is discontinuous.
④	Power indicator
⑤	Emergency stop button: The button cuts off the system power supply when an accidental situation takes place.
⑥	Delta power module DVP-PS02/24VDC
⑦	RTU-ECAT device
⑧	Ground
⑨	Safety circuit

4.5.1 Ground

- The diameter of the ground should not be less than the diameters of the cables connected to the terminals L and N.
- If using multiple pieces of equipment, use a single-point ground.

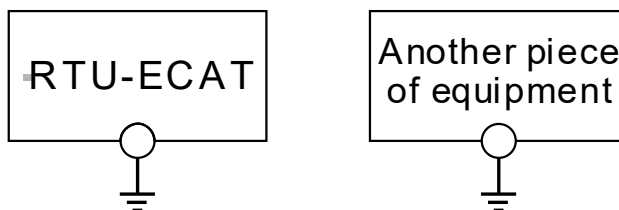

The single-point ground is better.

- If you cannot use a single-point ground, use a common-point ground.

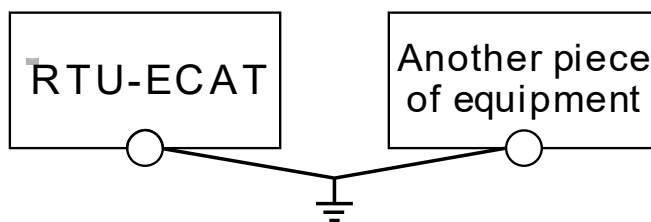

The common-point ground is permitted.

- Do not connect equipment ground wires together as shown below.

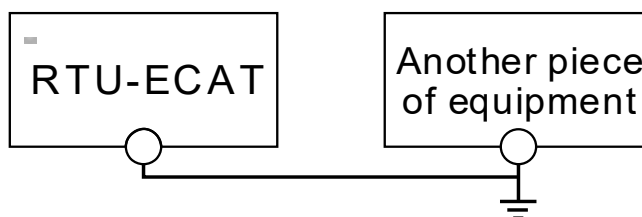

The equipment can not be grounded in this way.

MEMO

Chapter 5 Configuring RTU-ECAT

Table of Contents

5.1 Terms	5-2
5.2 Introduction to the Software Interfaces	5-3
5.2.1 Main Interface for RTU Configuration	5-3
5.2.2 DC Interface	5-3
5.2.3 Right-side Configuration of RTU-ECAT	5-4
5.2.4 Data Exchange Configuration Interface of Special Modules	5-5

This section describes how RTU-ECAT as an EtherCAT slave realizes the data exchange between EtherCAT master and DVP-S series extension modules.

- EtherCAT master transmits the data to extension modules.
- The input data from extension modules are transmitted back to EtherCAT master.

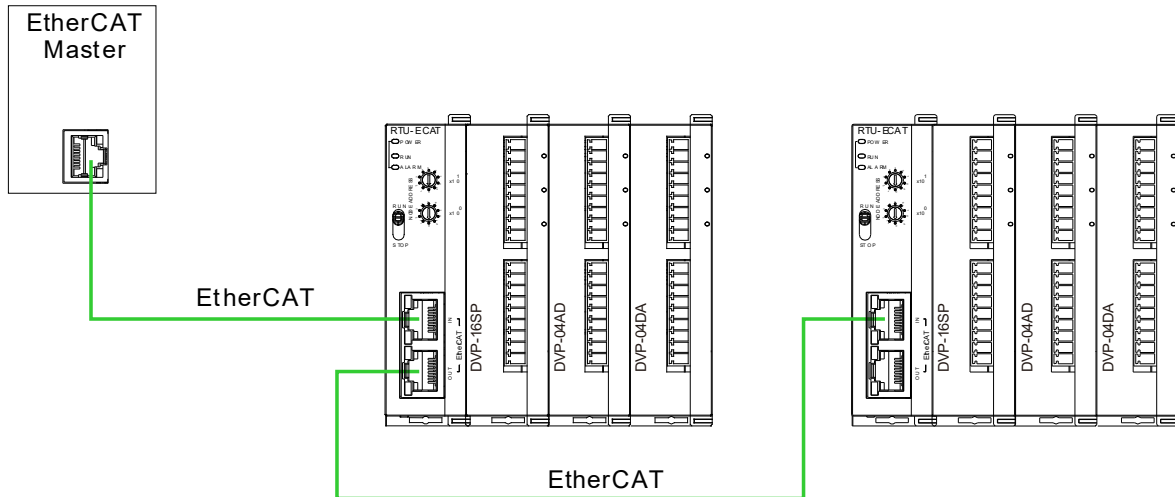

5

5.1 Terms

No.	Name	Unit	Explanation
1	Control word	Word	Sets the mode of RTU-ECAT. When the content of the control word is 8000Hex, RTU-ECAT is in STOP state. When the content of the control word is 8001Hex, RTU-ECAT is in RUN state. See section 6.3 for more details on the control word.
2	Status	Word	Status includes Error register (for error information), LV state (for voltage status), Error module number (for right-side module number) and Error list (for extension module errors) See section 6.3 for more details.
3	Digital input points	Bit	The number of digital input points is a multiple of 8. The number is regarded as 8 when it is less than 8 and as 16 when it is greater than 8 but less than 16.
4	Digital output points	Bit	The number of digital output points is a multiple of 8. The number is regarded as 8 when it is less than 8 and as 16 when it is greater than 8 but less than 16.
5	Special module number	Unit	Number of special modules connected to RTU-ECAT Range: 0~8
6	Input data length	Word	The total length of input data of special modules on the right of RTU-ECAT
7	Output data length	Word	The total length of output data of special modules on the right of RTU-ECAT

No.	Name	Unit	Explanation
8	IO mapping	N/A	The IO mapping between RTU-ECAT and the special modules connected to it.

5.2 Introduction to the Software Interfaces

This section introduces the configuration of RTU-ECAT by taking the TwinCAT3 software as an example.

5.2.1 Main Interface for RTU Configuration

Click on the RTU-ECAT symbol on the left list of the TwinCAT3 window as below. The main RTU configuration interface appears then.

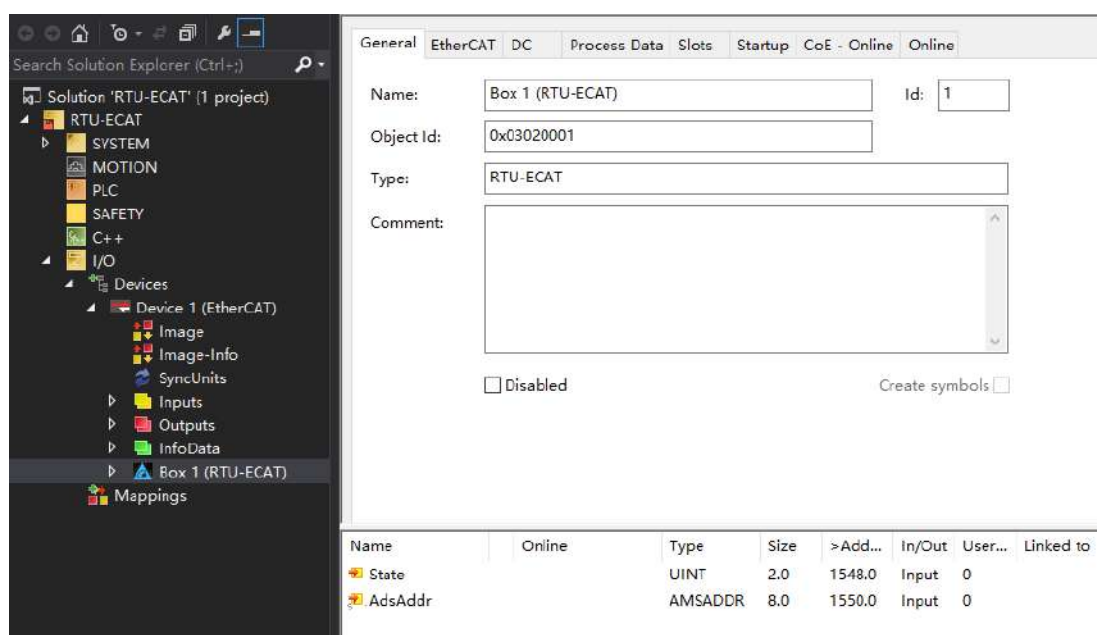

5.2.2 DC Interface

On the RTU configuration interface, open the DC interface with a click on **DC** tab.

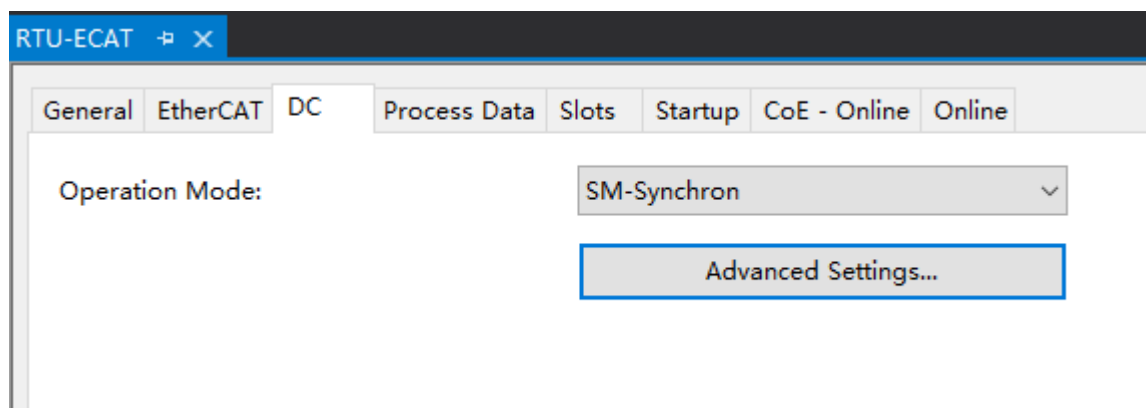

Operation Mode:

RTU-ECAT supports two operation modes, SM (Synchro Manager) and DC (Distributed Clock). Either of the two operation modes can be chosen from the pull-down box.

Advanced Settings:

When choosing DC as the operation mode, do related settings on the following “Advanced Settings” interface.

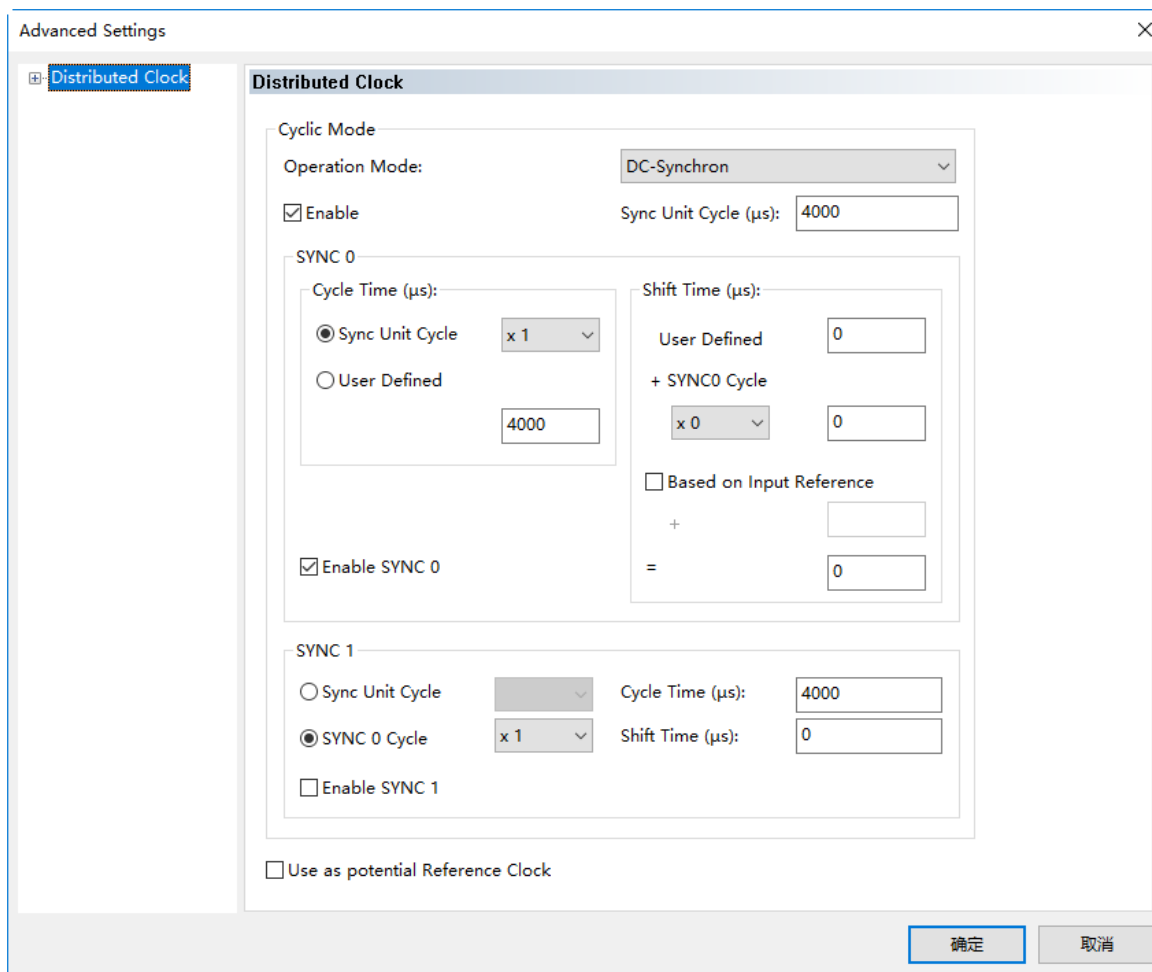

5

5.2.3 Right-side Configuration of RTU-ECAT

Click on **Slots** tab on the configuration interface of RTU-ECAT to go to the interface for configuring right-side modules.

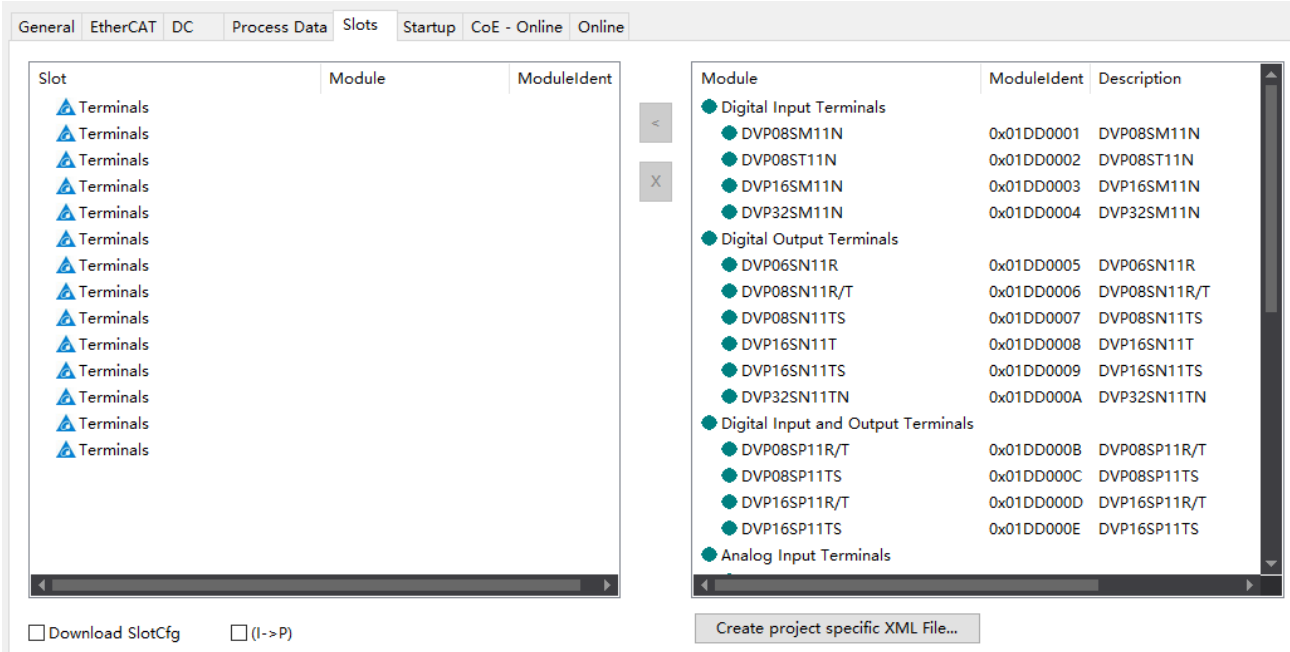

Select the upper “Terminals” row from the left list based on the actually configured modules on the right of RTU-ECAT. Then select the corresponding module from the right list and click on the  symbol to have the modules configured to RTU-ECAT.

Adding extension modules must start from the first “Terminals” row and no empty slot is allowed to exist between modules.

5.2.4 Data Exchange Configuration Interface of Special Modules

On the main RTU configuration interface, click on “**Process Data**” tab. The data exchange configuration interface of special modules appears then. Take the special module DVP06XA-S2 for example here.

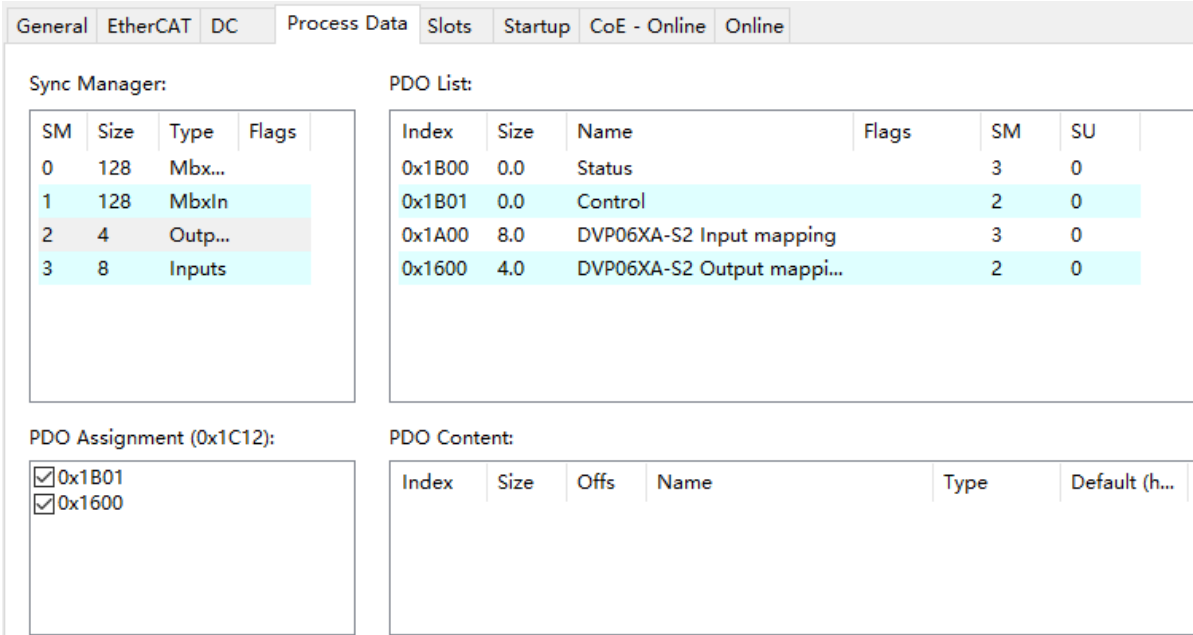

Explanation of PDO List on the configuration interface of special modules

Item	Description
Status	The parameters related to RTU-ECAT state and the CRs with the property of Read in the special modules which have been configured can be added or deleted
Control	The control word in RTU-ECAT and the CRs with the property of Write in the special modules which have been configured can be added or deleted.
DVP06XA-S2 Input mapping	The CRs with the property of Read in DVP06XA-S2 can be added or deleted.
DVP06XA-S2 Output mapping	The CRs with the property of Write in DVP06XA-S2 can be added or deleted.

How to configure the input/output mappings of special modules

Here is an example of the input mapping configuration.

Select the row where “DVP06XA-S2 Input mapping” is in the “PDO List” field and then configure input mapping parameters in the “PDO Content” field.

General
EtherCAT
DC
Process Data
Slots
Startup
CoE - Online
Online

Sync Manager:

SM	Size	Type	Flags
0	128	Mbx...	
1	128	MbxIn	
2	4	Outp...	
3	8	Inputs	

PDO List:

Index	Size	Name	Flags	SM	SU
0x1B00	0.0	Status		3	0
0x1B01	0.0	Control		2	0
0x1A00	8.0	DVP06XA-S2 Input mapping		3	0
0x1600	4.0	DVP06XA-S2 Output mappi...		2	0

PDO Assignment (0x1C12):

- 0x1B01
- 0x1600

PDO Content (0x1A00):

Index	Size	Offs	Name	Type	Default (h...
0x2000...	2.0	0.0	CR12: present value of CH1 input signal	INT	
0x2000...	2.0	2.0	CR13: present value of CH2 input signal	INT	
0x2000...	2.0	4.0	CR14: present value of CH3 input signal	INT	
0x2000...	2.0	6.0	CR15: present value of CH4 input signal	INT	
		8.0			

Select one of the rows in the red box above and right click on the selected row. Then a pull-down menu appears as below.

PDO Content (0x1A00):

Index	Size	Offs	Name	Type	Default (h...
0x2000...	2.0	0.0	CR12: present value of CH1 input signal	INT	
0x2000...	2.0	2.0	CR13: present value of CH2 input signal	INT	
0x2000...	2.0	4.0	CR14: present value of CH3 input signal	INT	
0x2000...	2.0	6.0	CR15: present value of CH4 input signal	INT	
		8.0			

Predefined PDO Assignment: (none)

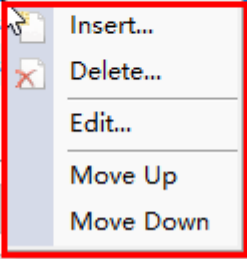

Explanation of the pull-down menu

Item	Description
Insert	Add or insert a CR with the property of Read in the module. Selecting "Insert" in the place of an existing CR means to insert a CR row here. Selecting "Insert" in the empty place means to add a CR row in the end.
Delete	Delete one CR which has already been added
Edit	Edit current parameter information such as Name, Index, Sub Index, Data Type and etc.
Move Up	Move to the previous row
Move Down	Move to the next row

MEMO

Chapter 6 Introduction of Parameters

Table of Contents

6.1 Parameters for Right-side Special Modules	6-2
6.2 Parameters for Connection Status of Right-Side Modules	6-5
6.3 Control Word and Status Indication Parameters	6-6
6.3.1 Control Word Parameter	6-6
6.3.2 Status Indication	6-7

6.1 Parameters for Right-side Special Modules

The index of the special module on the right of RTU-ECAT ranges from 16#2000 to 16#21A0 and the index value is determined by the position of the special module on the right of RTU-ECAT. For example, when the special module is the first one on the right of RTU-ECAT, its index is 16#2000. When the special module is the second one on the right of RTU-ECAT, its index is 16#2020. Similarly, when the special module is the 14th one on the right of RTU-ECAT, its index is 16#21A0.

As shown below, DVP04DA-S, DVP04AD-S, DVP16SP11T and DVP06XA-S are connected on the right of RTU-ECAT in order and then the index for DVP04DA-S is 16#2000, for DVP04AD-S is 16#2020 and for DVP06XA-S is 16#2060.

Slot	Module	ModuleIdent
▲ Terminals	DVP04DA-S	0x01DD0013
▲ Terminals	DVP04AD-S	0x01DD000F
▲ Terminals	DVP16SP11R/T	0x01DD000D
▲ Terminals	DVP06XA-S	0x01DD0015
▲ T . I		

Each subindex of a special module corresponds to one CR parameter of the special module. When the special module is located as the first one on the right of RTU-ECAT, the index 16#2000 and subindex 16#1 correspond to CR0 of the special module. When the special module is the second one on the right of RTU-ECAT, the index 16#2020 and subindex 16#7 correspond to CR6 of the special module.

6

For example, DVP04DA-S, DVP04AD-S, DVP16SP11T and DVP06XA-S are connected on the right of RTU-ECAT in order and the indexes and subindexes for DVP06XA-S parameters are showned below.

2060:0		DVP06XA-S CR		
2060:01	CR0: module type	RO P	---	
2060:02	CR1: input mode setting	RW P	---	
2060:03	CR2: CH1 average times	RW P	---	
2060:04	CR3: CH2 average times	RW P	---	
2060:05	CR4: CH3 average times	RW P	---	
2060:06	CR5: CH4 average times	RW P	---	
2060:07	CR6: average value of CH1 inp...	RO P	---	
2060:08	CR7: average value of CH2 inp...	RO P	---	
2060:09	CR8: average value of CH3 inp...	RO P	---	
2060:0A	CR9: average value of CH4 inp...	RO P	---	
2060:0B	CR10: CH5 output signal value	RW P	---	
2060:0C	CR11: CH6 output signal value	RW P	---	
2060:0D	CR12: present value of CH1 in...	RO P	---	

Explanation of parameters for special modules on the right of RTU-ECAT

Index	Subindex	Description
16#2000	16#1	The index and subindex that CR0 parameter corresponds to when the special module is located as the 1 st one on the right of RTU-ECAT.
	16#2	The index and subindex that CR1 parameter corresponds to when the special module is located as the 1 st one on the right of RTU-ECAT.

16#2020	16#1	The index and subindex that CR0 parameter corresponds to when the special module is located as the 2 nd one on the right of RTU-ECAT.
	16#2	The index and subindex that CR1 parameter corresponds to when the special module is located as the 2 nd one on the right of RTU-ECAT.

16#2040	16#1	The index and subindex that CR0 parameter corresponds to when the special module is located as the 3 rd one on the right of RTU-ECAT.
	16#2	The index and subindex that CR1 parameter corresponds to when the special module is located as the 3 rd one on the right of RTU-ECAT.

16#2060	16#1	The index and subindex that CR0 parameter corresponds to when the special module is located as the 4 th one on the right of RTU-ECAT.
	16#2	The index and subindex that CR1 parameter corresponds to when the special module is located as the 4 th one on the right of RTU-ECAT.

16#2080	16#1	The index and subindex that CR0 parameter corresponds to when the special module is located as the 5 th one on the right of RTU-ECAT.
	16#2	The index and subindex that CR1 parameter corresponds to when the special module is located as the 5 th one on the right of RTU-ECAT.

16#20A0	16#1	The index and subindex that CR0 parameter corresponds to when the special module is located as the 6 th one on the right of RTU-ECAT.
	16#2	The index and subindex that CR1 parameter corresponds to when the special module is located as the 6 th one on the right of RTU-ECAT.

16#20C0	16#1	The index and subindex that CR0 parameter corresponds to when the special module is located as the 7 th one on the right of RTU-ECAT.
	16#2	The index and subindex that CR1 parameter corresponds to when the special module is located as the 7 th one on the right of RTU-ECAT.

16#20E0	16#1	The index and subindex that CR0 parameter corresponds to when the special module is located as the 8 th one on the right of RTU-ECAT.
	16#2	The index and subindex that CR1 parameter corresponds to when the special module is located as the 8 th one on the right of

Index	Subindex	Description
		RTU-ECAT.

16#2100	16#1	The index and subindex that CR0 parameter corresponds to when the special module is located as the 9 th one on the right of RTU-ECAT.
	16#2	The index and subindex that CR1 parameter corresponds to when the special module is located as the 9 th one on the right of RTU-ECAT.

16#2120	16#1	The index and subindex that CR0 parameter corresponds to when the special module is located as the 10 th one on the right of RTU-ECAT.
	16#2	The index and subindex that CR1 parameter corresponds to when the special module is located as the 10 th one on the right of RTU-ECAT.

16#2140	16#1	The index and subindex that CR0 parameter corresponds to when the special module is located as the 11 th one on the right of RTU-ECAT.
	16#2	The index and subindex that CR1 parameter corresponds to when the special module is located as the 11 th one on the right of RTU-ECAT.

16#2160	16#1	The index and subindex that CR0 parameter corresponds to when the special module is located as the 12 th one on the right of RTU-ECAT.
	16#2	The index and subindex that CR1 parameter corresponds to when the special module is located as the 12 th one on the right of RTU-ECAT.

16#2180	16#1	The index and subindex that CR0 parameter corresponds to when the special module is located as the 13 th one on the right of RTU-ECAT.
	16#2	The index and subindex that CR1 parameter corresponds to when the special module is located as the 13 th one on the right of RTU-ECAT.

16#21A0	16#1	The index and subindex that CR0 parameter corresponds to when the special module is located as the 14 th one on the right of RTU-ECAT.
	16#2	The index and subindex that CR1 parameter corresponds to when the special module is located as the 14 th one on the right of RTU-ECAT.

6.2 Parameters for Connection Status of Right-Side Modules

The index 16#8200 shows the actual connection state of the modules on the right of RTU-ECAT

8200:0	Detected information	RO	
8200:01	Digital in	RO	---
8200:02	Digital out	RO	---
8200:03	Analog module number	RO	---
8200:04	Analog module ID1	RO	---
8200:05	Analog module ID2	RO	---
8200:06	Analog module ID3	RO	---
8200:07	Analog module ID4	RO	---
8200:08	Analog module ID5	RO	---
8200:09	Analog module ID6	RO	---
8200:0A	Analog module ID7	RO	---
8200:0B	Analog module ID8	RO	---

Explanation of parameters

Index	Subindex	Description	Data type	Access type
16#8200	16#1	The number of digital input points	Word	RO
	16#2	The number of digital output points	Word	RO
	16#3	The number of special modules	Word	RO
	16#4	The model code of the 1 st special module	Word	RO
	16#5	The model code of the 2 nd special module	Word	RO
	16#6	The model code of the 3 rd special module	Word	RO
	16#7	The model code of the 4 th special module	Word	RO
	16#8	The model code of the 5 th special module	Word	RO
	16#9	The model code of the 6 th special module	Word	RO
	16#A	The model code of the 7 th special module	Word	RO
	16#B	The model code of the 8 th special module	Word	RO

6.3 Control Word and Status Indication Parameters

6.3.1 Control Word Parameter

Explanation of control word parameter

Index	Subindex	Description	Data type	Access type
16#A100	16#1	Control Word	WORD	RW

Explanation of control word parameter bits

Bit	Value	Description
Bit 0	0	RTU-ECAT is set to STOP as bit 15 of the control word parameter is 1 and bit 0 is 0.
	1	RTU-ECAT is set to RUN as bit 15 of the control word parameter is 1 and bit 0 is 1.
Bit 1	0	The output values of right-side special modules and digital output point values of digital modules keep the same as they are before disconnection when RTU-EtherCAT is disconnected from the master.
	1	The output values of right-side special modules change to zero and digital output points of digital modules change to OFF when RTU-EtherCAT is disconnected from the master.
Bit 2	0/1	Reserved
Bit 3	0/1	Reserved
Bit 4	0/1	Reserved
Bit 5	0/1	Reserved
Bit 6	0/1	Reserved
Bit 7	0/1	Reserved
Bit 8	0/1	Reserved
Bit 9	0/1	Reserved
Bit 10	0/1	Reserved
Bit 11	0/1	Reserved
Bit 12	0/1	Reserved
Bit 13	0/1	Reserved
Bit 14	0/1	Reserved
Bit 15	0	Control word is disabled. When the bit value is 0, RTU-ECAT can not be controlled to enter RUN or STOP state via bit0 in the control word.

Bit	Value	Description
	1	Control word is enabled. When the bit value is 1, RTU-ECAT can be controlled to enter RUN or STOP state via bit0 in the control word.

6.3.2 Status Indication

List of RTU-ECAT status indication parameters

Index	Subindex	Description	Data type	Access type
16#1001	16#0	Error register which contains RTU-ECAT error information	WORD	RO
16#A000	16#1	LV state which is voltage status	BYTE	RO
	16#2	Error module number which is the number of the module in error on the right side	BYTE	RO
	16#3	Error list which shows errors of extension modules	ARRAY [1..8] OF BYTE	RO

Explanation of RTU-ECAT status indication parameters

■ Error register (RTU-ECAT error)

Status value	Description	How to correct
0x1000 (4096)	The special modules on the right of RTU-ECAT are inconsistent with the configuration in the software.	<ol style="list-style-type: none"> 1. Ensure that the special modules configured in the software match the modules actually connected. 2. Ensure that the connection between the right-side special modules and RTU-ECAT is normal.
0x1001 (4097)	The special modules and digital modules on the right of RTU-ECAT are inconsistent with the configuration data.	<ol style="list-style-type: none"> 1. Ensure that the special module number and input and output point numbers of digital modules configured in the software match the modules actually connected. 2. Ensure that the connection between the right-side modules and RTU-ECAT is normal.

Status value	Description	How to correct
0x1002 (4098)	An error occurs in the special modules on the right of RTU-ECAT	<ol style="list-style-type: none"> 1. Ensure that the power supply to the right-side special modules is normal. 2. Check the error information of the special modules on the right of RTU-ECAT. Configure the error status CR registers for the right-side special modules to the input data of IO data and then get to know the cause based on the values in the error status CRs. Refer to error status CRs in DVP-PLC Application Manual: Special Modules for more details on error codes of special modules.
0x1004 (4100)	The modules configured in the software are inconsistent with those actually connected and meanwhile an error in extension modules on the right of RTU-ECAT occurs.	<ol style="list-style-type: none"> 1. Ensure the modules configured in the software match those actually connected. 2. Ensure the power supply to the right-side modules works normally. 3. Check the error information of the right-side modules and then get rid of it according to the instructions in the module manual.
0x1005 (4101)	The special modules configured on the right of RTU-ECAT exceeds 8 units.	Ensure that the number of special modules configured in the software is no more than 8 units.

6

■ LV state (voltage status)

Bit	Value	Description	How to correct
Bit 0	0	The voltage for RTU-ECAT is normal.	--
	1	The voltage for RTU-ECAT is abnormal.	Check if the voltage of the power supply to RTU-ECAT is normal.
Bit 1~bit 7	0/1	Reserved	Reserved

■ Error module number (The number of the right-side module in error)

Bit	Value	Description	How to correct
Bit 0	0	The 1 st special module on the right of RTU-ECAT is normal.	--

Bit	Value	Description	How to correct
	1	The 1 st special module on the right of RTU-ECAT is alarming.	Refer to “Error list (Extension module error information)” below.
Bit 1	0	The 2 nd special module on the right of RTU-ECAT is normal.	--
	1	The 2 nd special module on the right of RTU-ECAT is alarming.	Refer to “Error list (Extension module error information)” below.
Bit 2	0	The 3 rd special module on the right of RTU-ECAT is normal.	--
	1	The 3 rd special module on the right of RTU-ECAT is alarming.	Refer to “Error list (Extension module error information)” below.
Bit 3	0	The 4 th special module on the right of RTU-ECAT is normal.	--
	1	The 4 th special module on the right of RTU-ECAT is alarming.	Refer to “Error list (Extension module error information)” below.
Bit 4	0	The 5 th special module on the right of RTU-ECAT is normal.	--
	1	The 5 th special module on the right of RTU-ECAT is alarming.	Refer to “Error list (Extension module error information)” below.
Bit 5	0	The 6 th special module on the right of RTU-ECAT is normal.	--
	1	The 6 th special module on the right of RTU-ECAT is alarming.	Refer to “Error list (Extension module error information)” below.
Bit 6	0	The 7 th special module on the right of RTU-ECAT is normal.	--
	1	The 7 th special module on the right of RTU-ECAT is alarming.	Refer to “Error list (Extension module error information)” below.
Bit 7	0	The 8 th special module on the right of RTU-ECAT is normal.	--
	1	The 8 th special module on the right of RTU-ECAT is alarming.	Refer to “Error list (Extension module error information)” below.

■ Error list (Extension module error information)

Bit	Description
Error list[0]	The error code in the 1 st special module on the right of RTU-ECAT; the error code value is the value in the error status CR of the special module. For details, refer to error status CRs in DVP-PLC Application Manual: Special Modules.
Error list[1]	The error code in the 2 nd special module on the right of RTU-ECAT; the error code value is the value in the error status CR of the special module. For details, refer to error status CRs in DVP-PLC Application Manual: Special Modules.
Error list[2]	The error code in the 3 rd special module on the right of RTU-ECAT; the error code value is the value in the error status CR of the special module. For details, refer to error status CRs in DVP-PLC Application Manual: Special Modules.
Error list[3]	The error code in the 4 th special module on the right of RTU-ECAT; the error code value is the value in the error status CR of the special module. For details, refer to error status CRs in DVP-PLC Application Manual: Special Modules.
Error list[4]	The error code in the 5 th special module on the right of RTU-ECAT; the error code value is the value in the error status CR of the special module. For details, refer to error status CRs in DVP-PLC Application Manual: Special Modules.
Error list[5]	The error code in the 6 th special module on the right of RTU-ECAT; the error code value is the value in the error status CR of the special module. For details, refer to error status CRs in DVP-PLC Application Manual: Special Modules.
Error list[6]	The error code in the 7 th special module on the right of RTU-ECAT; the error code value is the value in the error status CR of the special module. For details, refer to error status CRs in DVP-PLC Application Manual: Special Modules.
Error list[7]	The error code in the 8 th special module on the right of RTU-ECAT; the error code value is the value in the error status CR of the special module. For details, refer to error status CRs in DVP-PLC Application Manual: Special Modules.

Chapter 7 Application Examples

Table of Contents

- 7.1 Using Delta AX8 Series CPU with RTU-ECAT 7-3**
- 7.2 Using TwinCAT3 with RTU-ECAT 7-13**
 - 7.2.1 Configuring the Network via TwinCAT3 7-13
 - 7.2.2 Controlling RTU-ECAT’s Right-side Modules via PLC 7-24
- 7.3 Using OMRON NJ301 with RTU-ECAT 7-27**

This part describes how to configure RTU-ECAT module parameters through examples. Section 7.1, 7.2 and 7.3 respectively introduce the configuration methods when RTU-ECAT works together with different EtherCAT masters.

Voltage output

● **Control requirement**

1. DVP16SP11T is controlled to change its outputs Y0~Y7 to ON and its inputs X0~X7 are monitored via RTU-ECAT.
2. Channel 1 ~ channel 4 of DVP04DA-S are controlled to output the voltage of 5V via RTU-ECAT.
3. The analog data conversion values of Channel 1 ~ channel 4 of DVP04AD-S are read via RTU-ECAT.

● **Digital-Analog Relations for DVP04DA-S and DVP04AD-S**

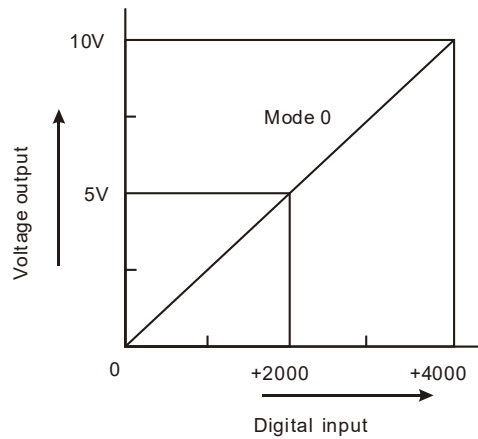

Digital input- Voltage output relation for DVP04DA-S in mode 0

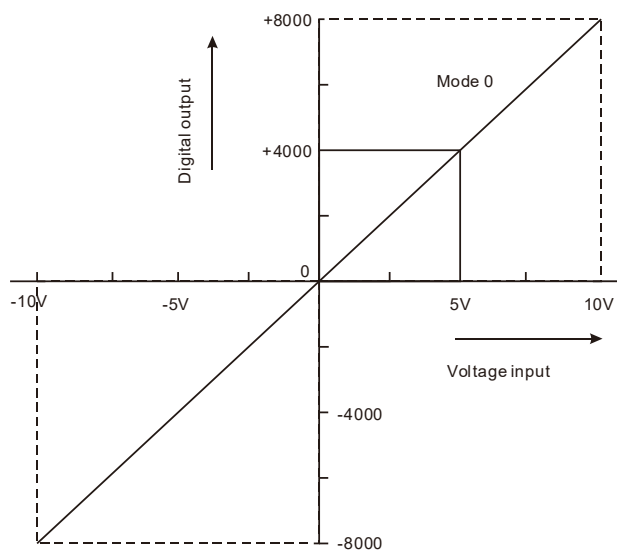

Digital output- Voltage input relation for DVP04AD-S in mode 0

- **Constructing an EtherCAT network with RTU-ECAT**

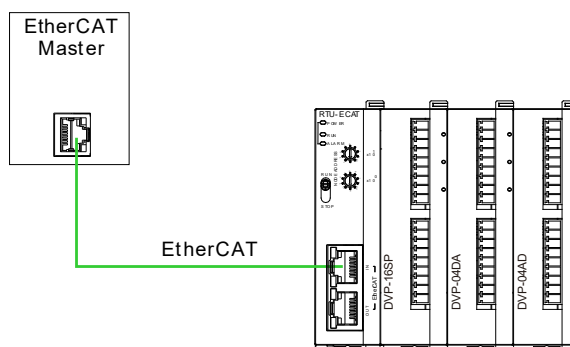

- **Devices used in the example:**

Device Name	Description
AX-832E CPU	Delta AX-8 series motion controller CPU
TwinCAT software	Beckhoff EtherCAT configuration software
NJ301	OMRON NJ series CPU
RTU-ECAT module	Delta EtherCAT remote IO module
DVP04DA-S	Delta analog output module
DVP04AD-S	Delta analog input module
DVP16SP11T	Delta digital IO module with 8 input points and 8 output points

Note:

1. Please ensure that DVP16SP11T, DVP04DA-S, DVP04AD-S and RTU-ECAT modules work normally and the whole network wiring is proper.
2. Refer to **DVP-PLC Application Manual: Special Modules** for more about DVP04DA-S and DVP04AD-S.

7.1 Using Delta AX8 Series CPU with RTU-ECAT

1. Download CODESYS software from Delta official website and install it. And then start the software.

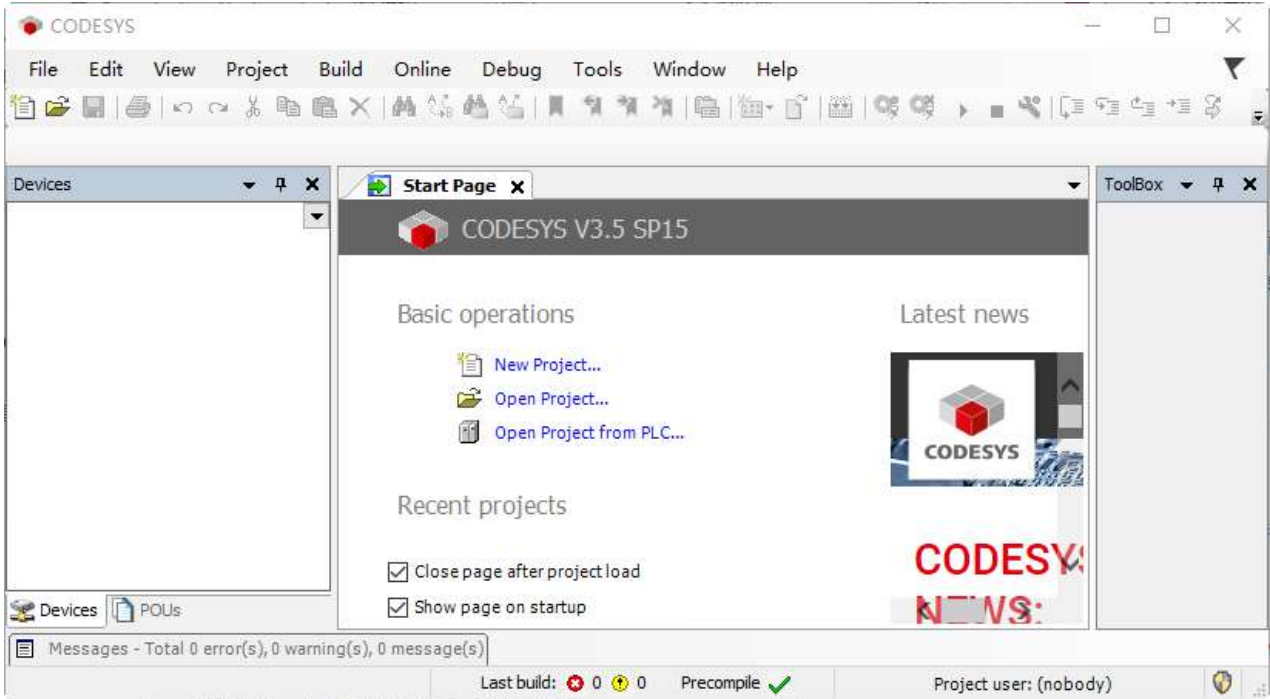

- 2. A new project is created by selecting the icon in the red box and then typing a project name and storage location as below.

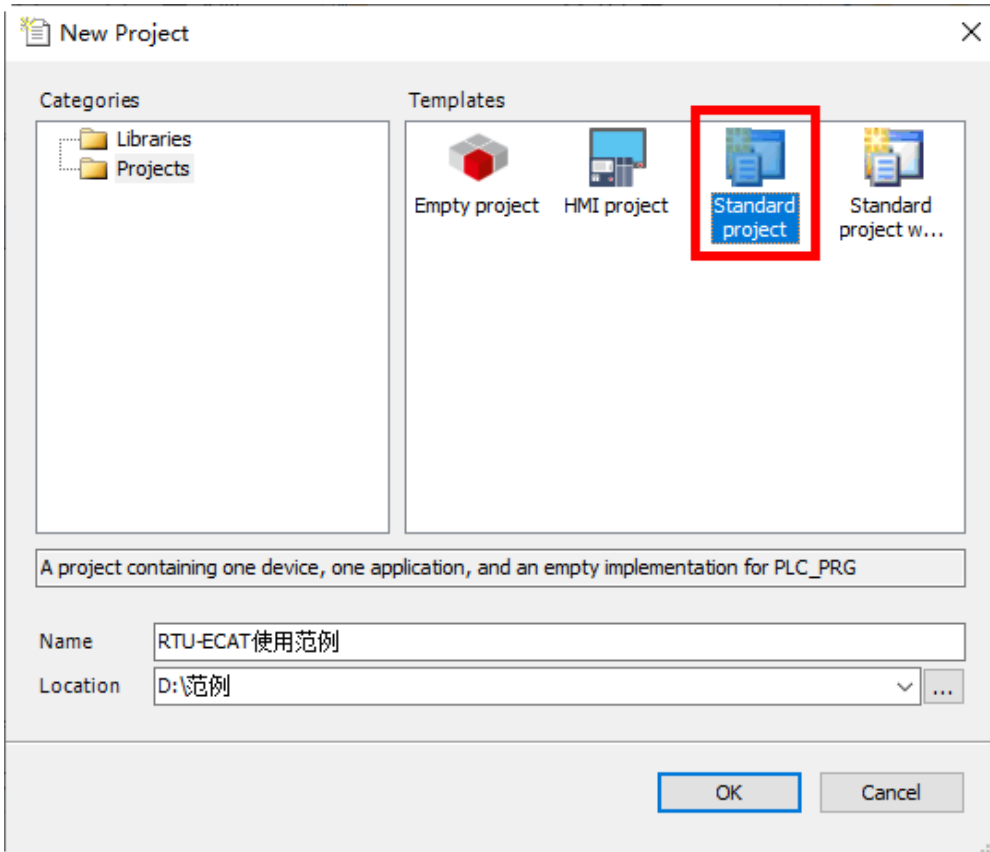

Click “OK” button to complete the setting. Afterward, select “AX-8xxEP0 Series (Delta Electronics, Inc.)” in the “Device” field and then click “OK” in the pop-out window.

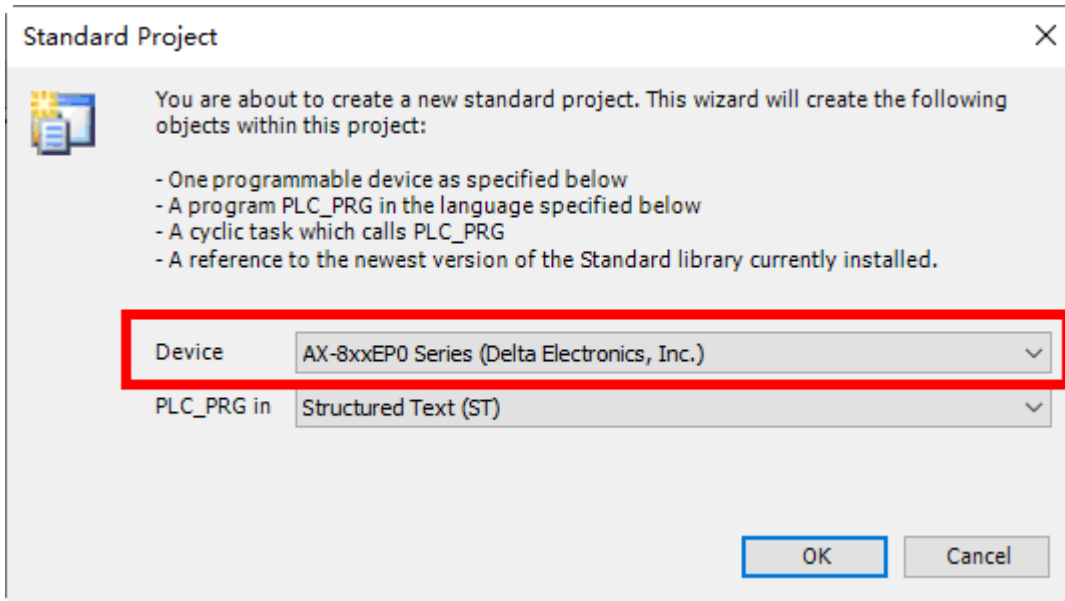

3. The created new project is shown as below.

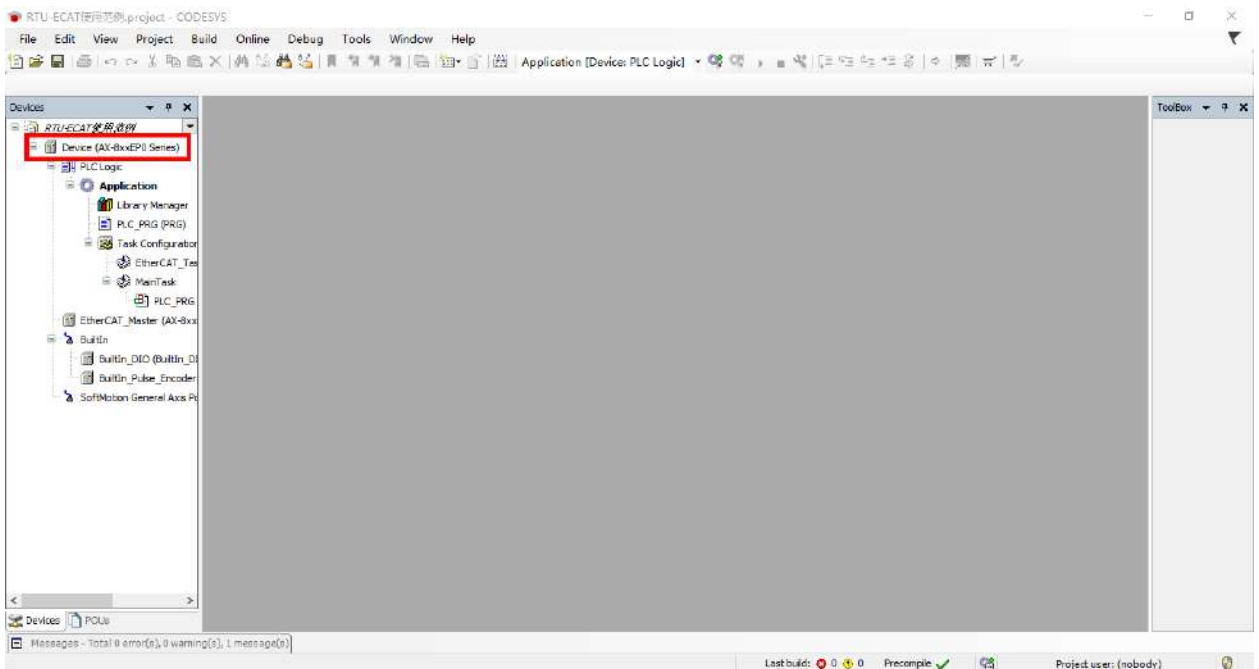

Double-click on "Device" in the red box above and then click on "Scan Network" in the red box in the following window.

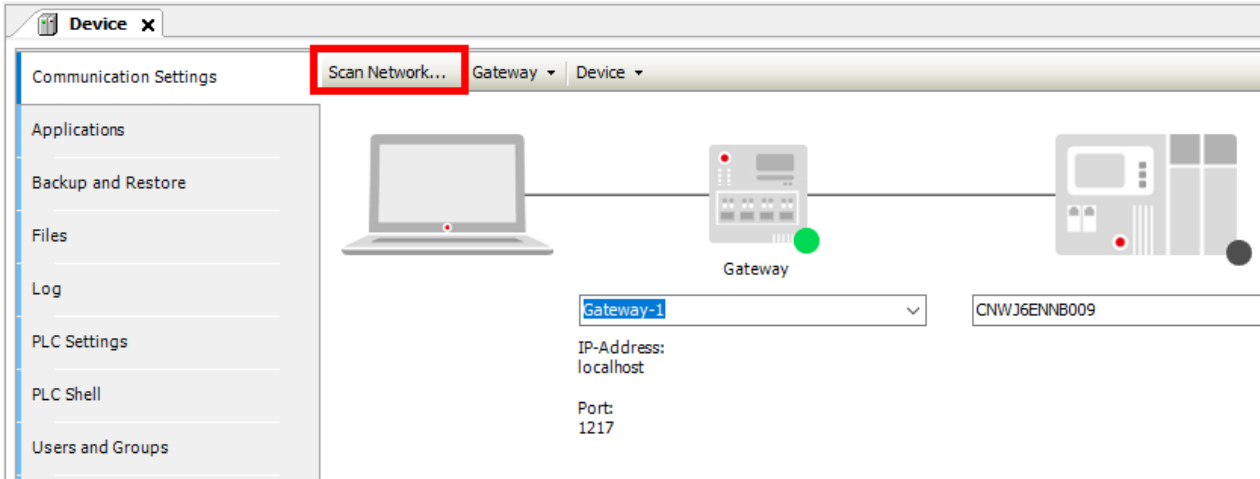

Then the following window appears, where AX-8 series controller will be searched automatically. After the AX-8 controller shows up, select the controller and click "OK" button.

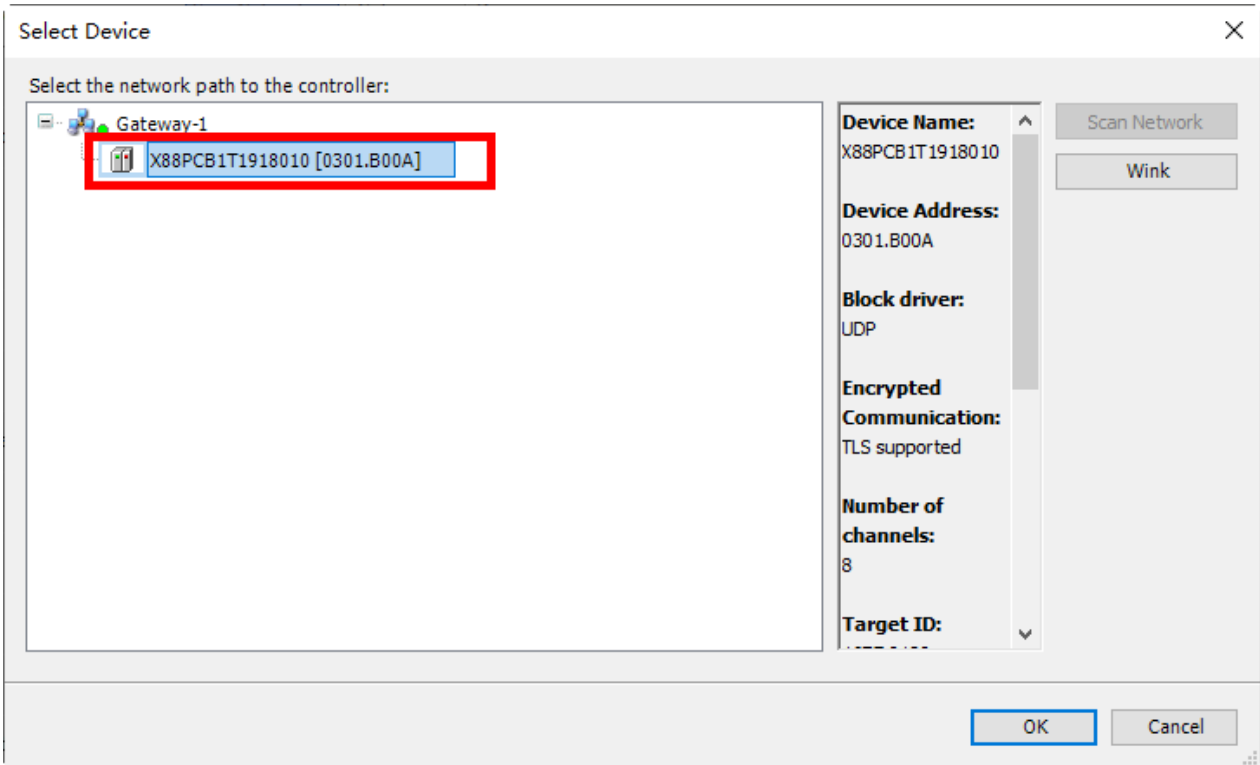

After the operations above are done, the connected CPU will automatically show up in the "Device" interface as below.

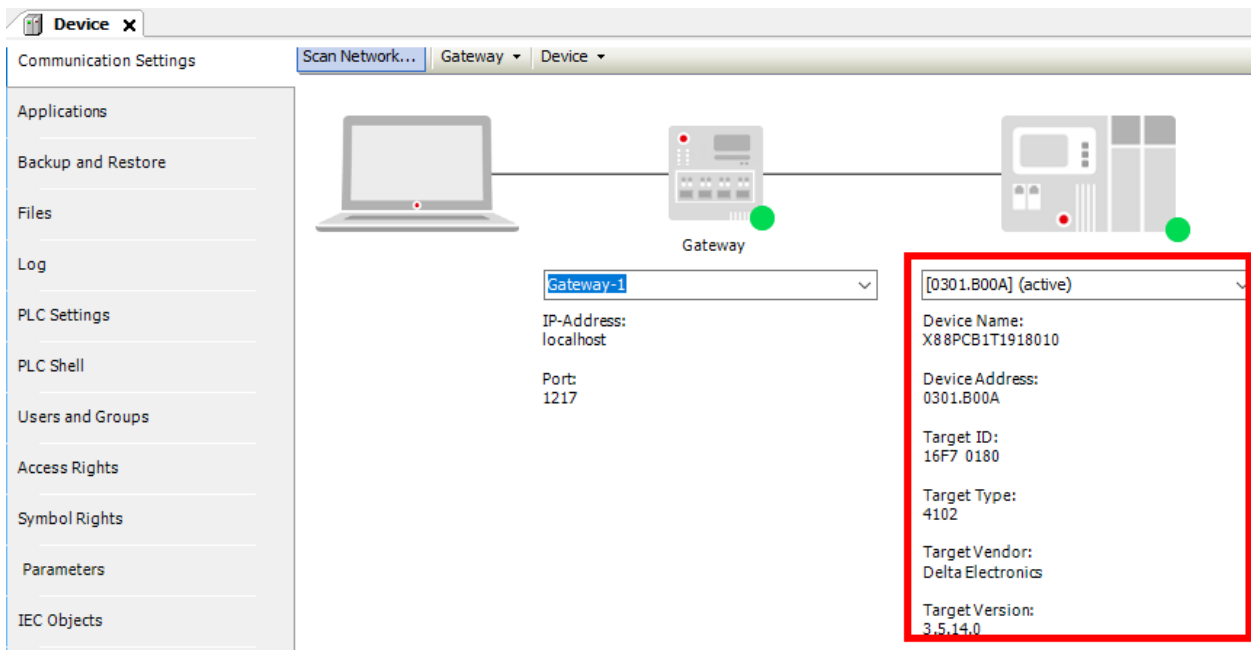

4. Double-click on “EtherCAT Master” in the red box below to open the “EtherCAT Master” interface.

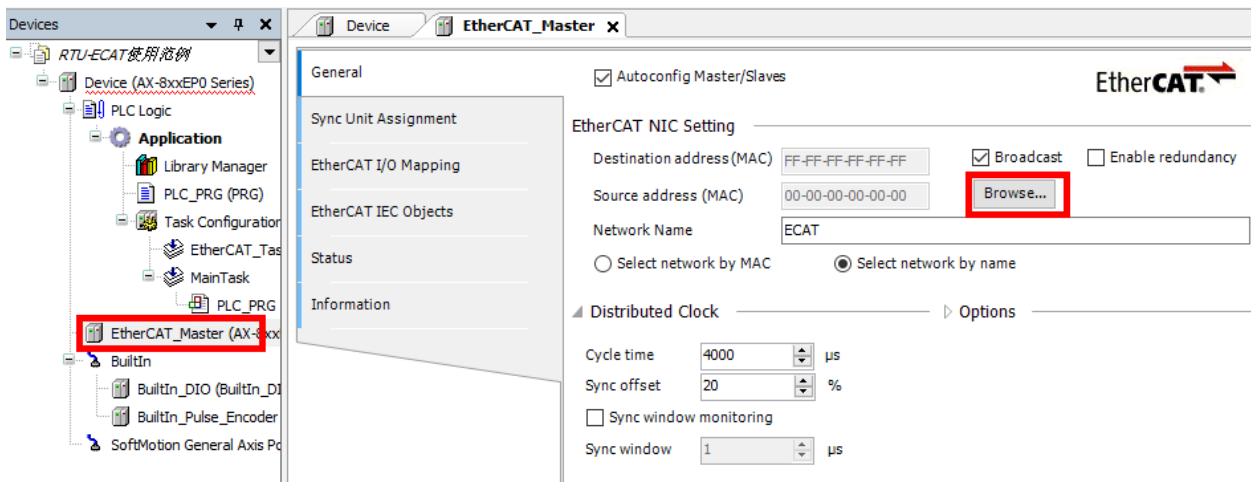

Click “Browse” button in the “EtherCAT Master” configuration area, then select the ECAT port from the pop-out “Select Network Adapter” window as below and afterwards click “OK” button.

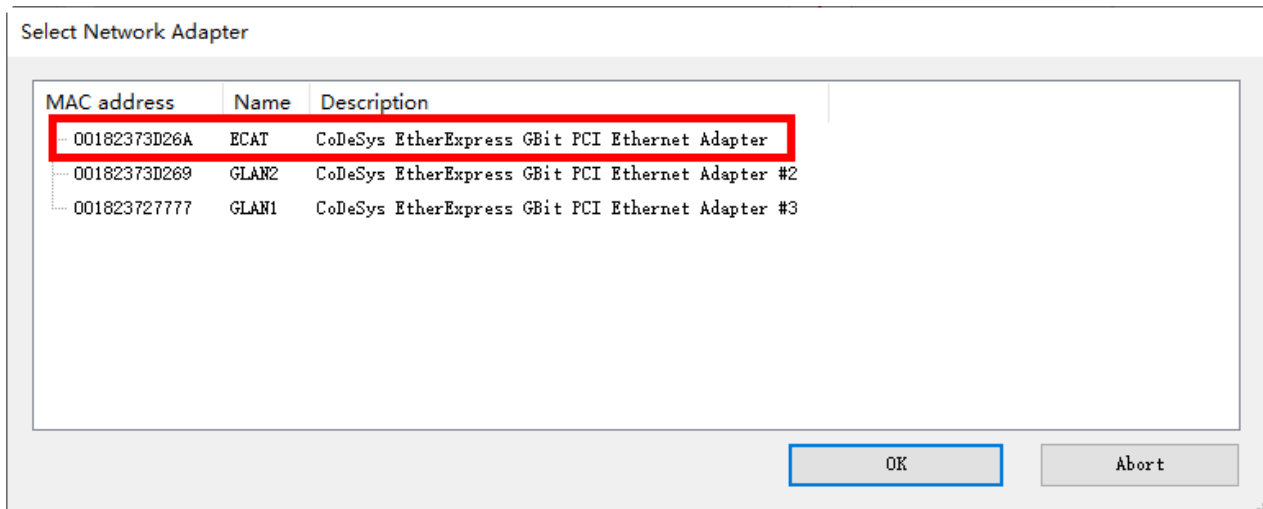

- 5. Right-click on the “EtherCAT Master” after the above action is done and then choose “Scan For Devices...” from the context menu.

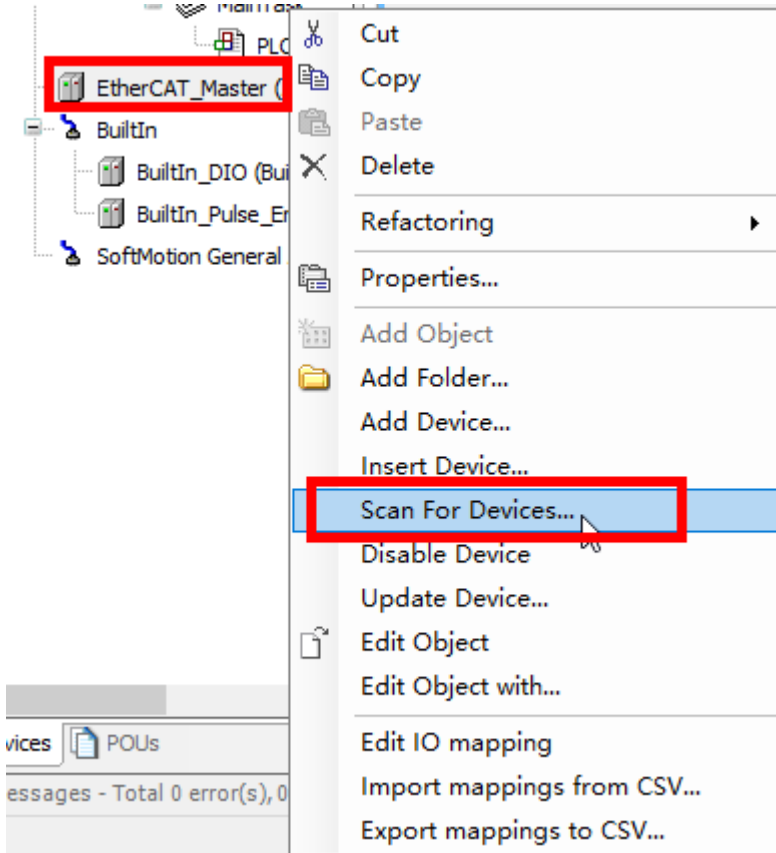

Then the following “Scan Devices” window appears with the scanned slave as follows.

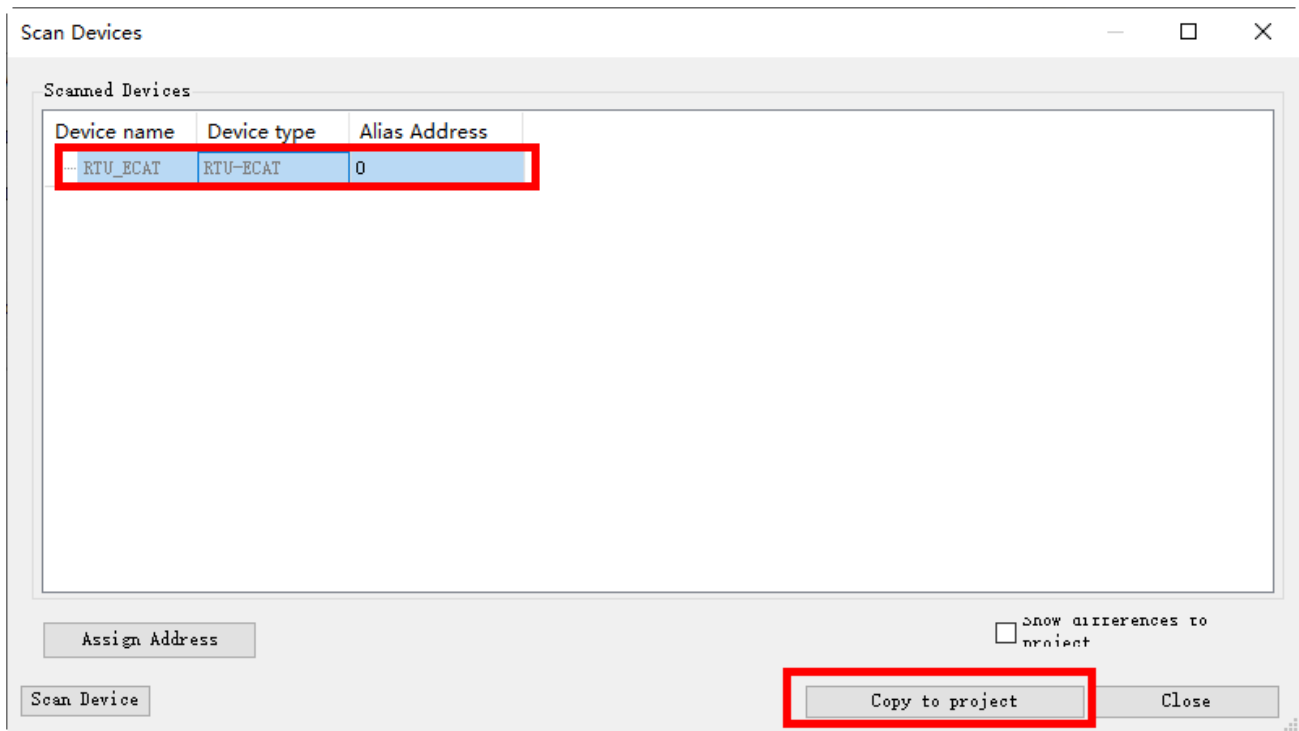

After the software scan is complete, select the scanned RTU-ECAT and then click on “Copy to project” to add

the RTU-ECAT to the EtherCAT configuration as shown below.

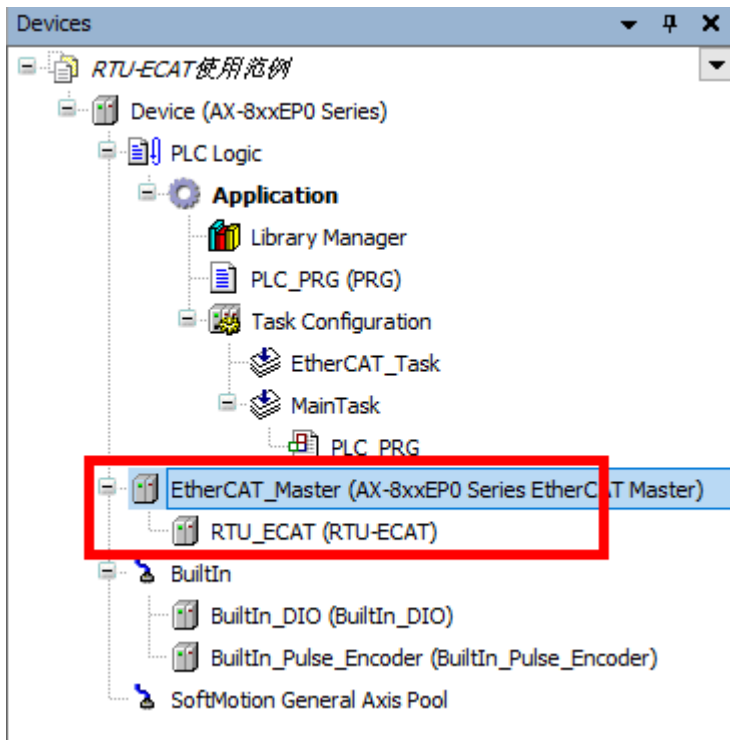

- Right-click on the RTU-ECAT after it is added and select “Add Device” from the context menu to add extension modules.

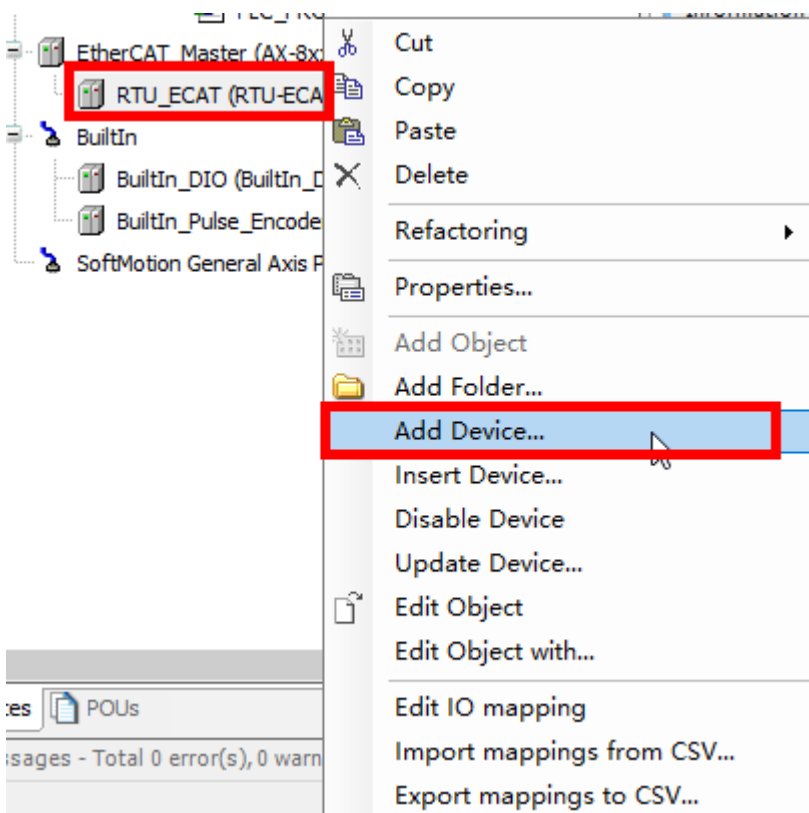

The following “Add Device” window appears for users to select extension modules.

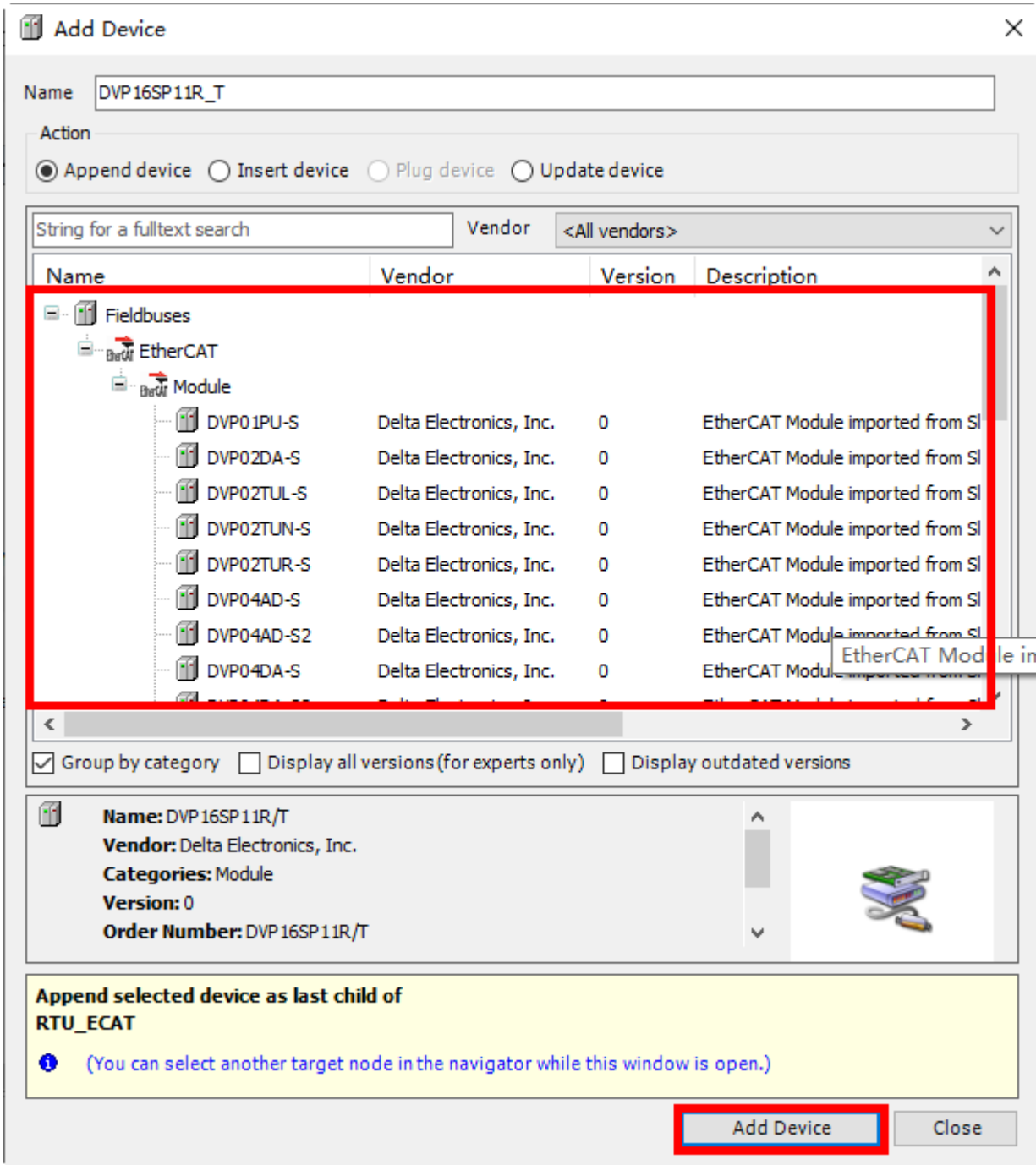

7

Find out and select DVP16SP11R/T in the red box above and then click “Add Device” button to add DVP16SP11T/R to RTU-ECAT. In the same way, add DVP04DA-S and DVP04AD-S respectively to the RTU-ECAT configuration.

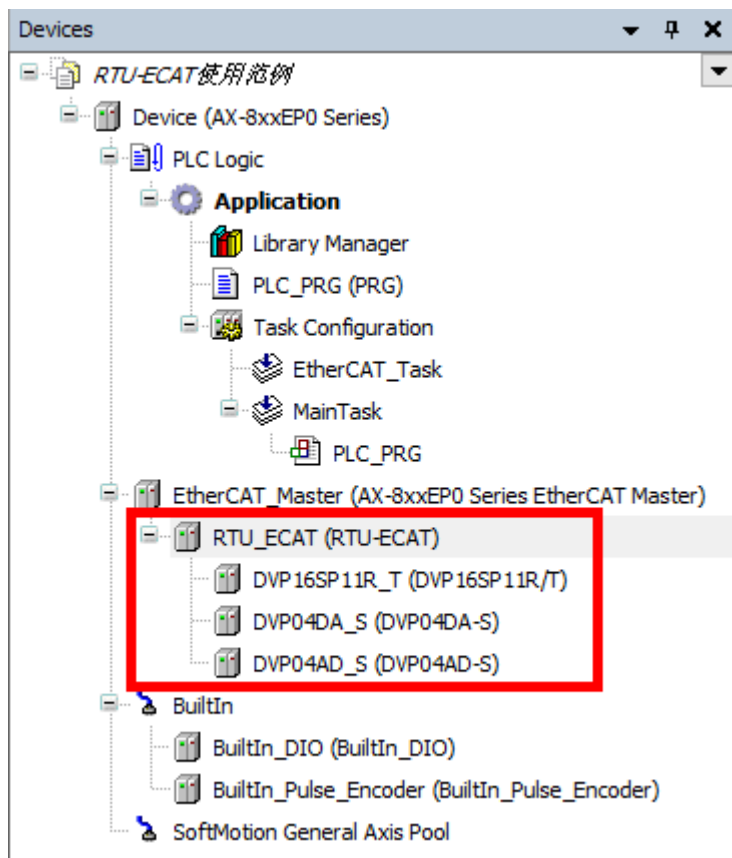

7. After the above configuration setting is complete, right-click on the RTU-ECAT and select “Edit IO Mapping” from the context menu to review the IO mapping information of RTU-ECAT.

Variable	Channel	Address	Type	Description
RTU_ECAT				
DVP16SP11R_T				
	Digital output CH1	%QB0	USINT	Digital output CH1
	Digital input CH1	%IB0	USINT	Digital input CH1
DVP04DA_S				
	CR6: value of CH1 output signal	%QW1	INT	CR6: value of CH1 output signal
	CR7: value of CH2 output signal	%QW2	INT	CR7: value of CH2 output signal
	CR8: value of CH3 output signal	%QW3	INT	CR8: value of CH3 output signal
	CR9: value of CH4 output signal	%QW4	INT	CR9: value of CH4 output signal
DVP04AD_S				
	CR12: present value of CH1 input signal	%IW1	INT	CR12: present value of CH1 input signal
	CR13: present value of CH2 input signal	%IW2	INT	CR13: present value of CH2 input signal
	CR14: present value of CH3 input signal	%IW3	INT	CR14: present value of CH3 input signal
	CR15: present value of CH4 input signal	%IW4	INT	CR15: present value of CH4 input signal

Variables can be combined in the red boxes above. When module channels are not combined to variables, the I and Q devices in the “Address” column are valid. The values of module channels can be read through



the I and Q devices in the program.

When module channels are combined to variables , the I and Q devices in the “Address” column are invalid. The values of module channels can be read through variables in the program.

E.g. when module channels are not combined with variables, write 255 in %QB0 device in the program to change the Y0~Y7 output of DVP16SP11T into ON. If channel 1~ channel 4 of DVP04DA-S output 5V voltage, write 2000 to %QW1~QW4 in the program and then read the value converted from the analog data of channel 1~ channel 4 of DVP04AD-S in %IW1~%IW4.

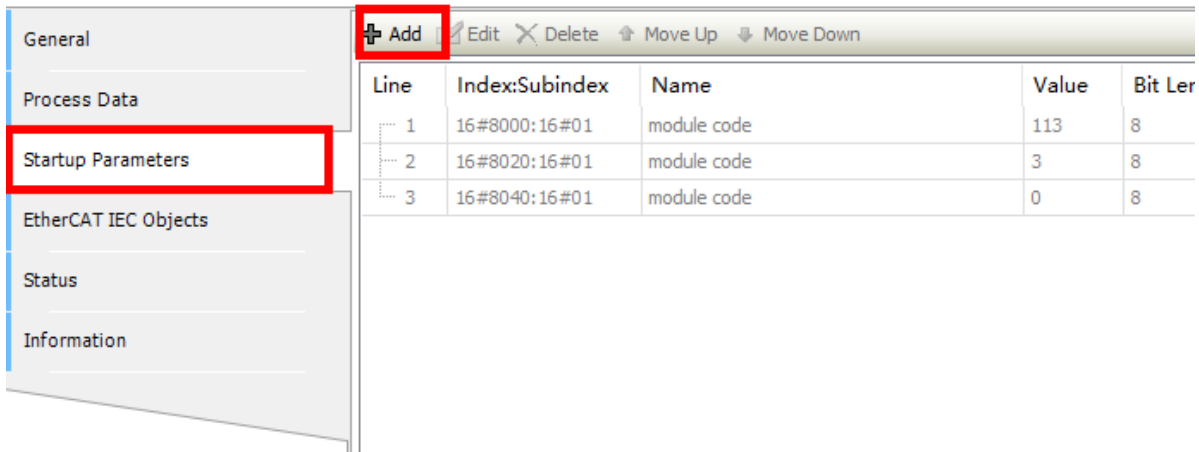
If you need to modify the mode of channel 1~ channel 4 of DVP04DA-S, click “Startup Parameters” in the configuration interface of RTU-ECAT to open the “Startup” configuration interface and then click  button as follows.



Click  button and then click  icon beside DVP04DA-S in the pop-out window to unfold all configurable CRs of DVP04DA-S. Then select the option “CR1: output mode setting” and enter 585 (16#249) in the “Value” field.

Select Item from Object Directory

Index:Subindex	Name	Flags	Type	Default
16#10F1:16#00	Error Settings			
16#1C32:16#00	SM output parameter			
16#1C33:16#00	SM input parameter			
6#2020:16#00	DVP04DA-S CR			
:16#02	CR1: output mode set...	RW	INT	16#0000
:16#03	CR2: reserved	RW	INT	16#0000
:16#04	CR3: reserved	RW	INT	16#0000
:16#05	CR4: reserved	RW	INT	16#0000
:16#06	CR5: reserved	RW	INT	16#0000
:16#07	CR6: value of CH1 ou...	RW	INT	16#0000
:16#08	CR7: value of CH2 ou...	RW	INT	16#0000
:16#09	CR8: value of CH3 ou...	RW	INT	16#0000
:16#0A	CR9: value of CH4 ou...	RW	INT	16#0000
:16#0B	CR10: reserved	RW	INT	16#0000

Name: CR1: output mode setting

Index: 16# 2020 Bit length: 16

SubIndex: 16# 2 Value: 585

Byte array

OK Cancel

Click “OK” button to finish the setting. The “Startup Parameters” interface is displayed as follows after the setting is over.

Line	Index:Subindex	Name	Value	Bit Length	Abort on Error	Jump to Line on Err...	Next Line	Comment
1	16#8000:16#01	module code	113	8	<input type="checkbox"/>	<input type="checkbox"/>	0	module code
2	16#8020:16#01	module code	3	8	<input type="checkbox"/>	<input type="checkbox"/>	0	module code
3	16#8040:16#01	module code	0	8	<input type="checkbox"/>	<input type="checkbox"/>	0	module code
4	16#2020:16#02	CR1: output mode setting	585	16	<input type="checkbox"/>	<input type="checkbox"/>	0	

Click  login button and download the EtherCAT configuration data to the AX8 series CPU. Then the mode of channel 1~ channel 4 of DVP04DA-S is automatically switched to mode 1.

Refer to **DVP-PLC Application Manual: Special Modules** for details on CR1 in DVP04DA-S.

7.2 Using TwinCAT3 with RTU-ECAT

7.2.1 Configuring the Network via TwinCAT3

■ Configuring RTU-ECAT

1. Start the TwinCAT3 software and create a TwinCAT project as below.

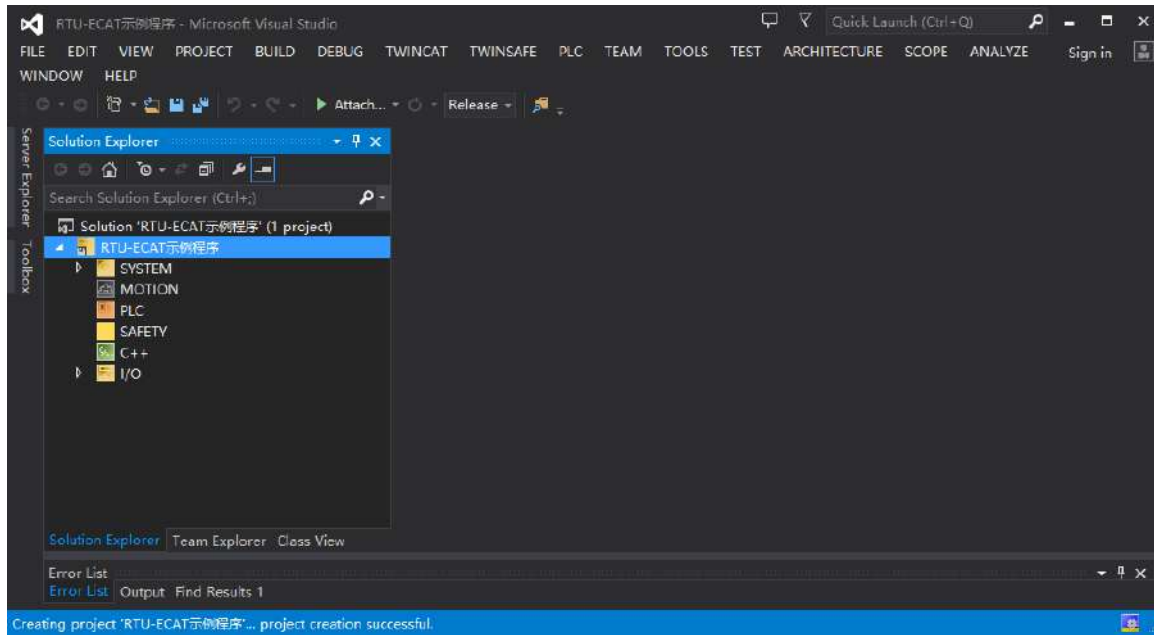

2. Click on the “I/O” item on the left list of the software interface, select “Devices” and then click on “Scan” of “TWINCAT” menu.

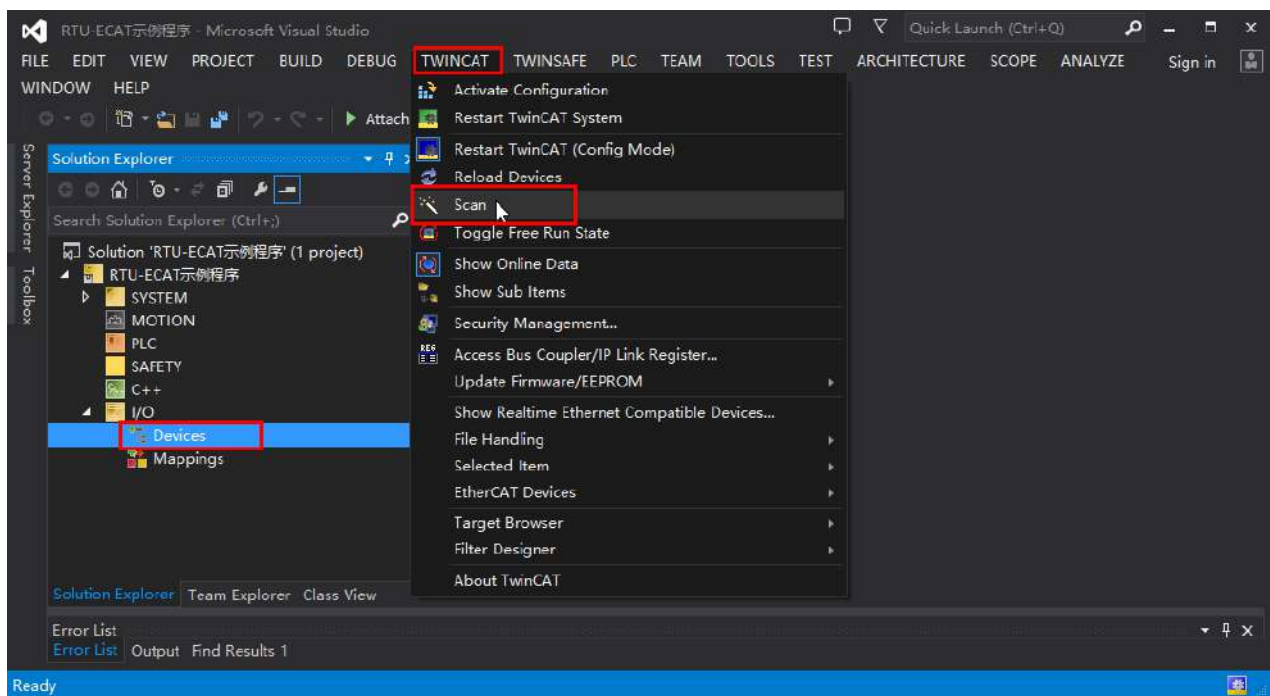

With a click on “Scan” the following dialog appears, where you click on the “OK” button.

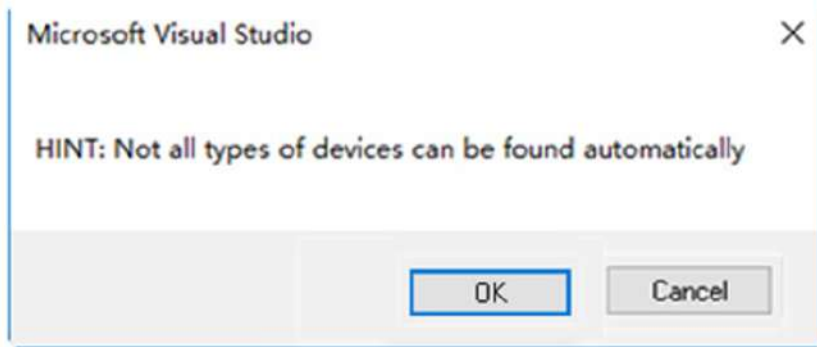

3. During the scan, the adapters information is listed as below. Select the right adapter and click on the “OK” button.

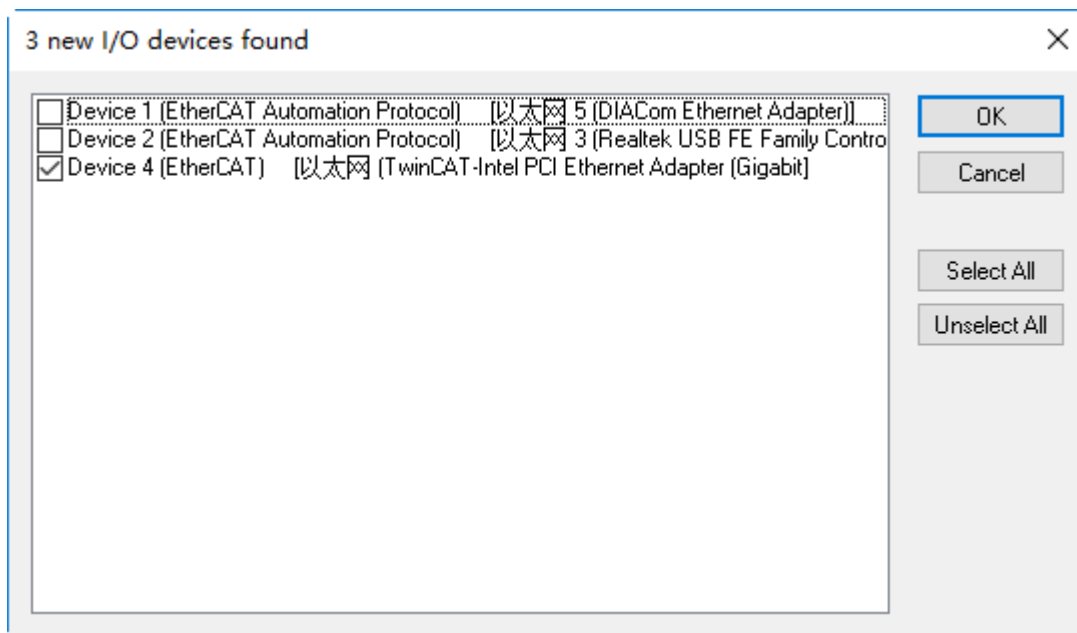

4. Click on the “Y” button in the following dialog to scan the slave modules on the network.

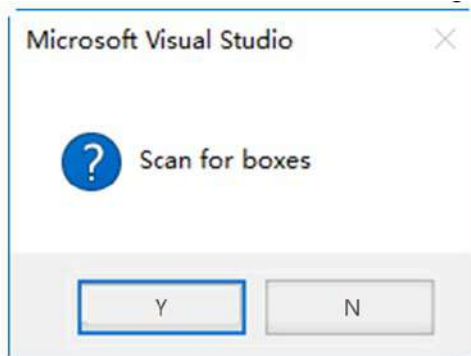

5. After the scan is over, the following dialog appears. Click on the “Y” button then.

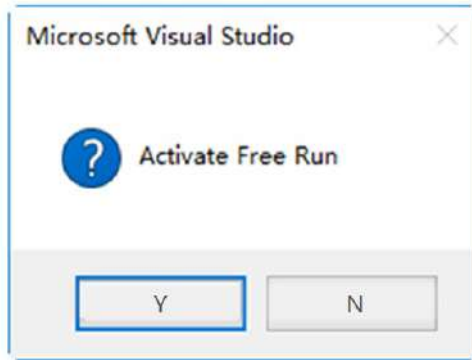

6. Then the names of all node devices which have been scanned appear on the software interface as follows.

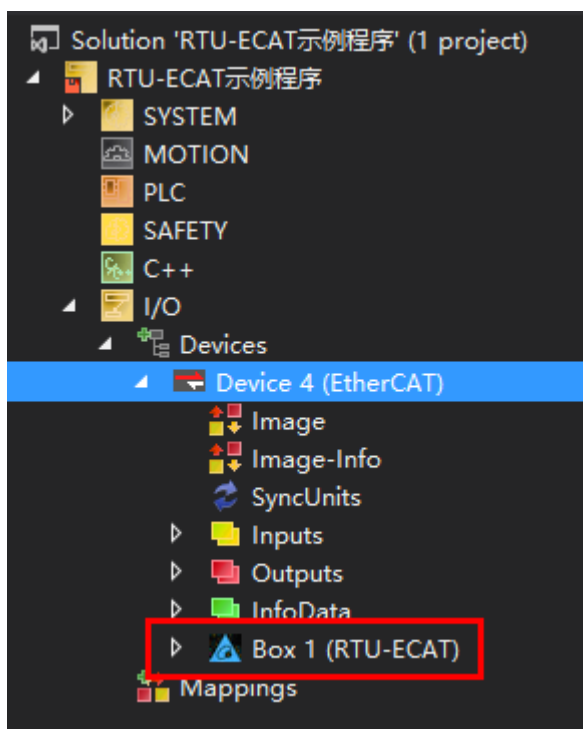

7

7. With a double-click on the RTU-ECAT symbol, the interface for configuring RTU-ECAT appears.

General | EtherCAT | DC | Process Data | Slots | Startup | CoE - Online | Online

Name: Id:

Object Id:

Type:

Comment:

Disabled Create symbols

8. Click on "Slots" tab and then set the right-side module configuration of RTU-ECAT as below.

General | EtherCAT | DC | Process Data | Slots | Startup | CoE - Online | Online

Slot	Module
▲ Terminals	
▲ Terminals	
▲ Terminals	
▲ Terminals	
▲ Terminals	
▲ Terminals	
▲ Terminals	
▲ Terminals	
▲ Terminals	
▲ Terminals	
▲ Terminals	
▲ Terminals	
▲ Terminals	
▲ Terminals	
▲ Terminals	
▲ Terminals	
▲ Terminals	

Module	ModuleIdent	Description

Download SlotCfg (I->P)

9. Click on the top "Terminals" row of the left list. Then the DVP-S series right-side extension modules which can be added appear on the right list.

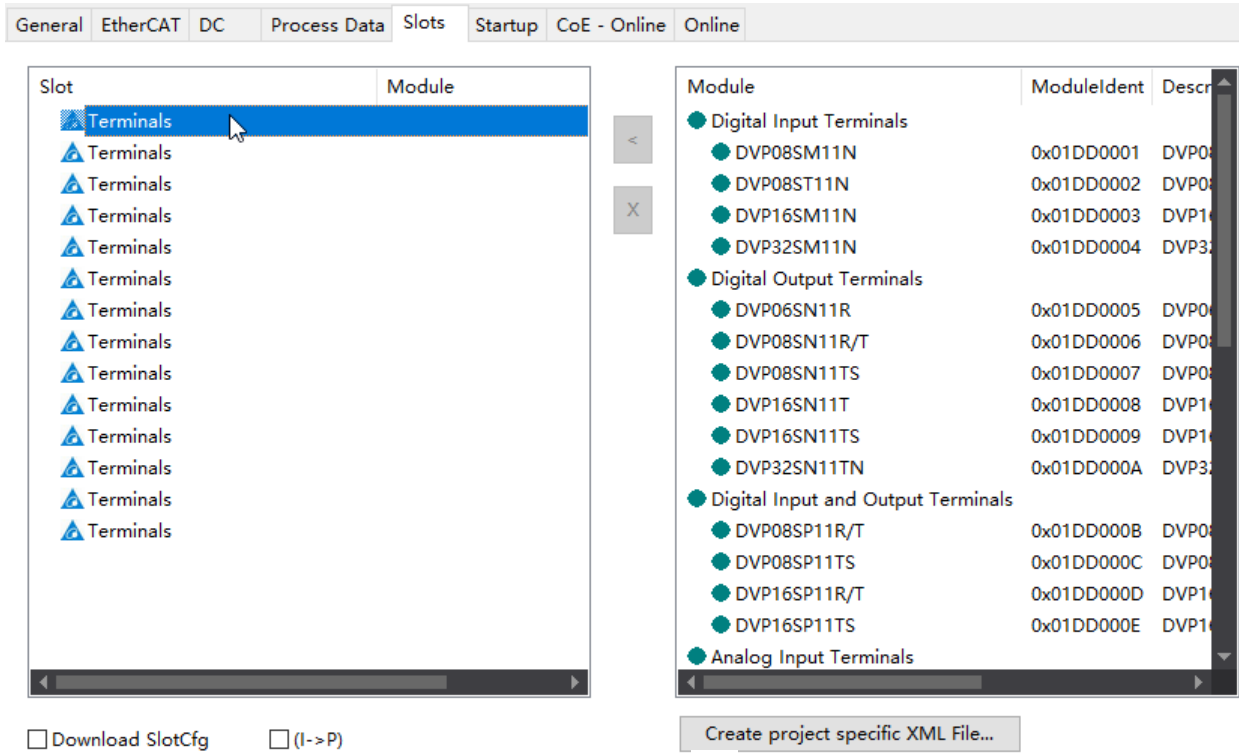

10. Select DVP16SP11R/T from the right list and click on  to add DVP16SP11R/T to the configuration list of RTU-ECAT.

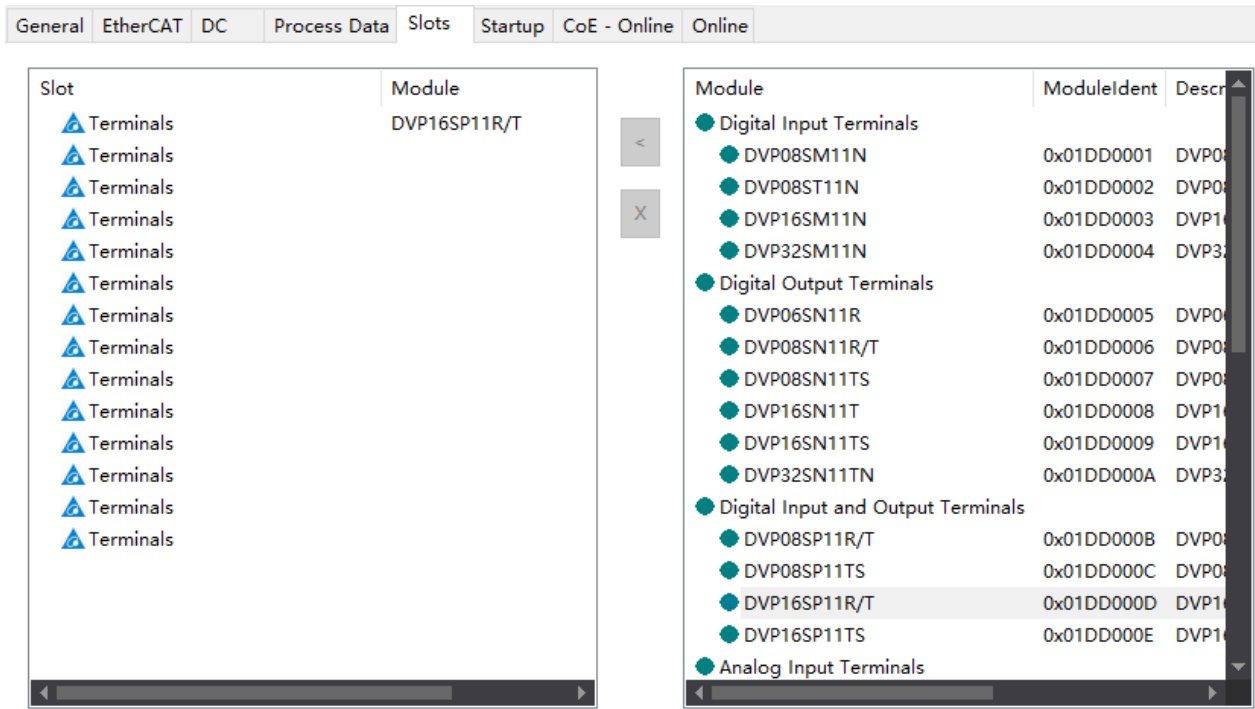

11. Following the steps above, add DVP04DA and DVP04AD under DVP16SP as below.

7

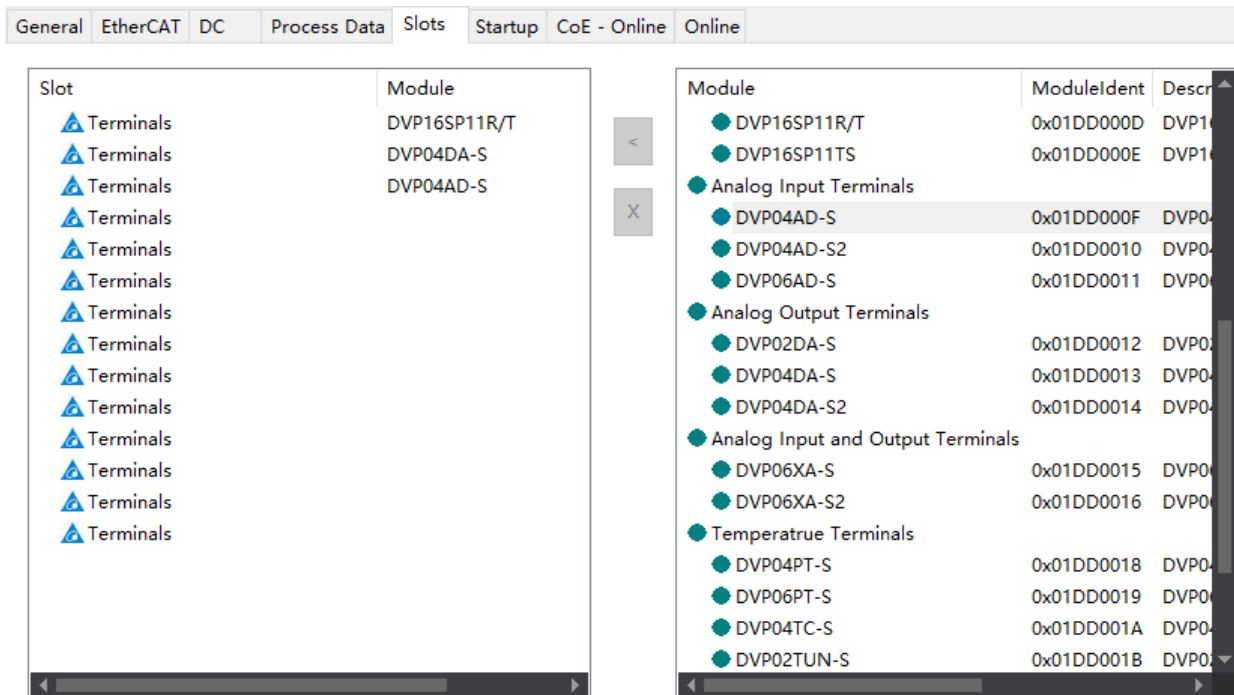

12. After the configuration is completed, click the “Process Data” tab to enter the data exchange configuration interface.

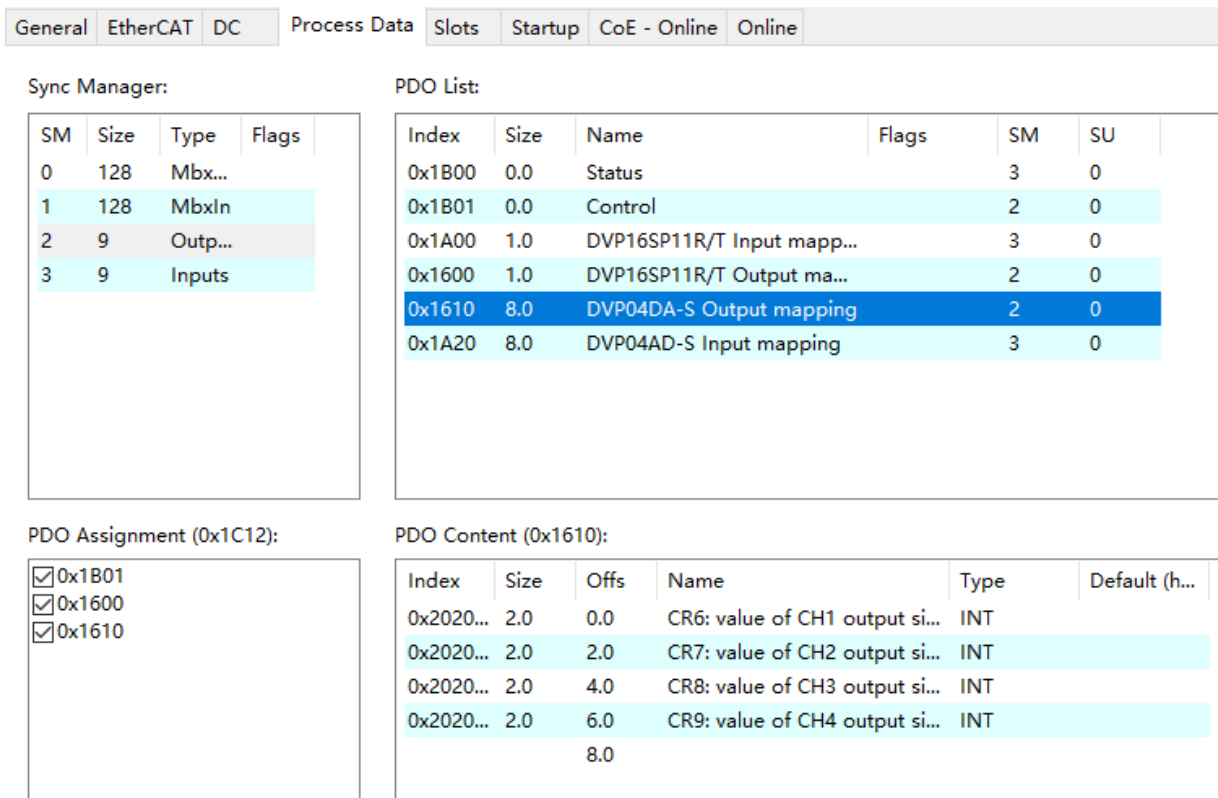

Add or delete a special module CR which need be read or written to in the “PDO Content” box as below.

PDO Content (0x1610):

Index	Size	Offs	Name	Type	Default (h...
0x2020...	2.0	0.0	CR6: value of CH1 output si...	INT	
0x2020...	2.0	2.0	CR7: value of CH2 output si...	INT	
0x2020...	2.0	4.0	CR8: value of CH3 output si...	INT	
0x2020...	2.0	6.0	CR9: value of CH4 output si...	INT	
		8.0			

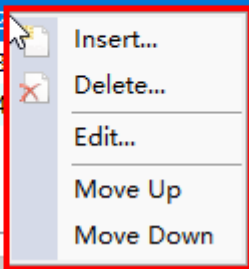

Explanation of the pull-down menu:

Item	Description
Insert	Add or insert a special module CR.
Delete	Delete a special module CR which has been added.
Edit	Edit the selected parameter
Move Up	Move to the previous row
Move Down	Move to the next row

- After the above setting is over, click on the “Activate Configuration” option on “TwinCAT” menu to make the current configuration effective.

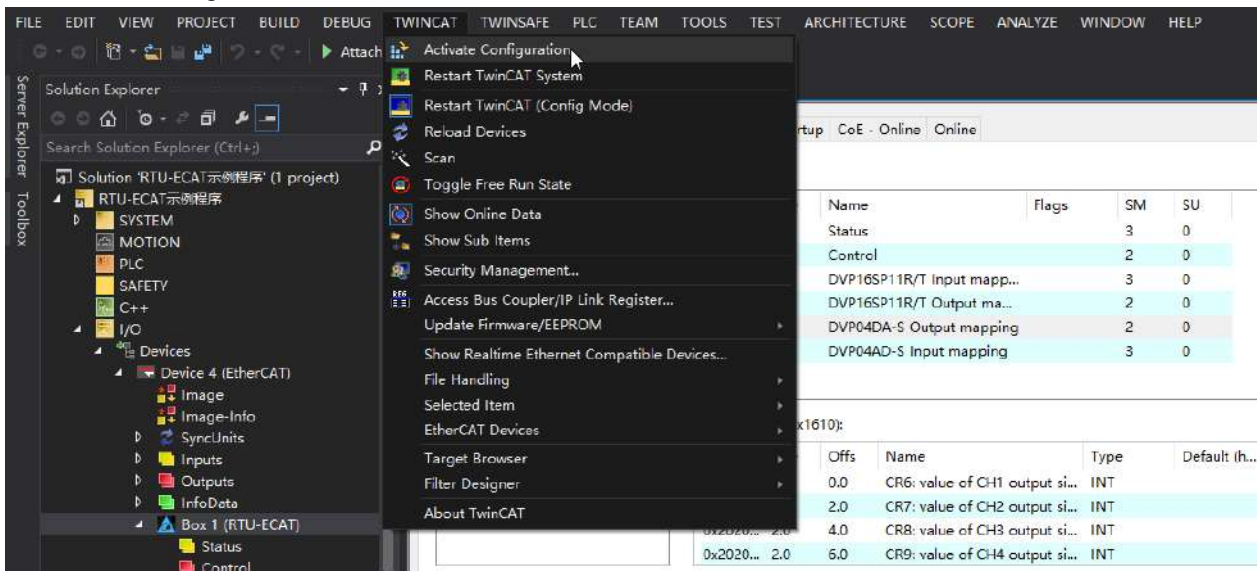

With a click on “Activate Configuration”, the following reminder dialog appears, where you click “OK” button.

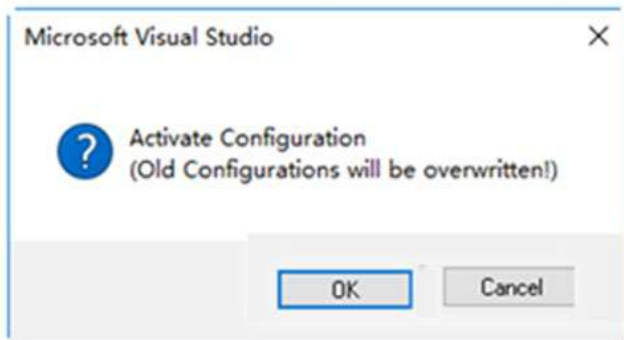

14. If the mode of channel 1~ channel 4 of DVP04DA-S need be modified, e.g. the mode of channel 1~ channel 4 is to be changed to mode 1, click “Startup” tab in the configuration interface of RTU-ECAT and then press “New...” button as shown in the red box below.

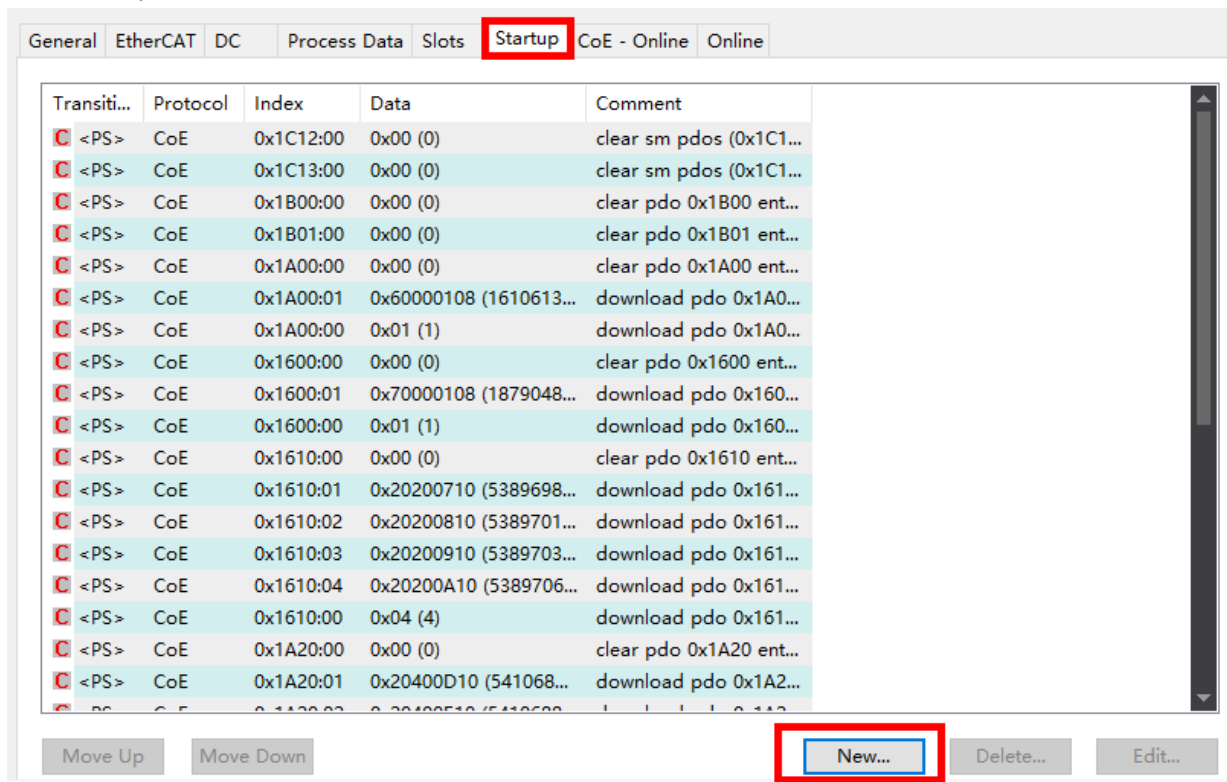

After pressing above “New..” button, click to unfold configurable CRs of DVP04DA-S in the following window.

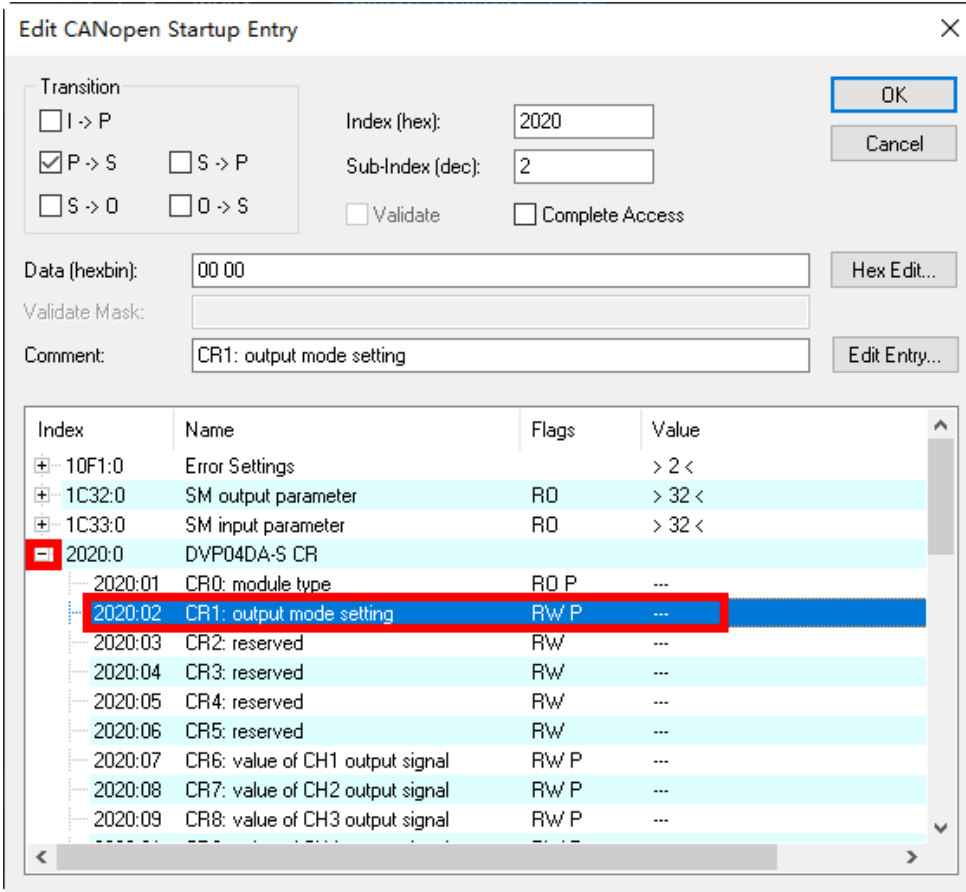

Double-click “CR1: output mode setting” in the red box above. Then set the value for CR1 in the following new window.

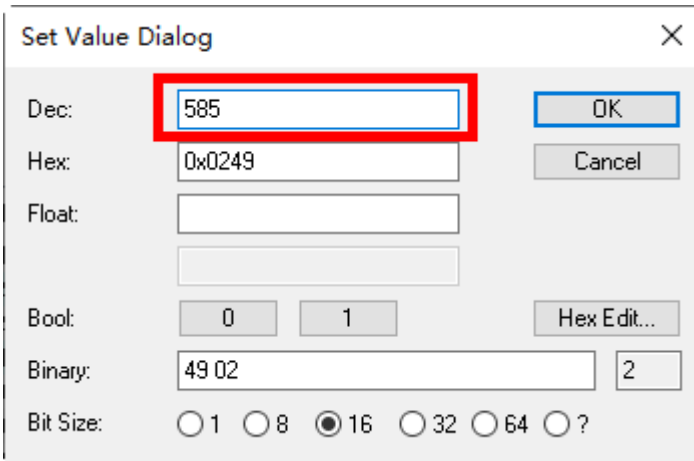

Click “OK” to close current window. After the setting is over, the CR1 parameter of DVP04DA-S which has been added can be seen in the “Startup” tab page.

General EtherCAT DC Process Data Slots Startup CoE - Online Online					
Transiti...	Protocol	Index	Data	Comment	
<PS>	CoE	0x1A20:00	0x00 (0)	clear pdo 0x1A20 ent...	
<PS>	CoE	0x1A20:01	0x20400D10 (541068...	download pdo 0x1A2...	
<PS>	CoE	0x1A20:02	0x20400E10 (5410688...	download pdo 0x1A2...	
<PS>	CoE	0x1A20:03	0x20400F10 (5410690...	download pdo 0x1A2...	
<PS>	CoE	0x1A20:04	0x20401010 (5410693...	download pdo 0x1A2...	
<PS>	CoE	0x1A20:00	0x04 (4)	download pdo 0x1A2...	
<PS>	CoE	0x1C12:01	0x1B01 (6913)	download pdo 0x1C1...	
<PS>	CoE	0x1C12:02	0x1600 (5632)	download pdo 0x1C1...	
<PS>	CoE	0x1C12:03	0x1610 (5648)	download pdo 0x1C1...	
<PS>	CoE	0x1C12:00	0x03 (3)	download pdo 0x1C1...	
<PS>	CoE	0x1C13:01	0x1B00 (6912)	download pdo 0x1C1...	
<PS>	CoE	0x1C13:02	0x1A00 (6656)	download pdo 0x1C1...	
<PS>	CoE	0x1C13:03	0x1A20 (6688)	download pdo 0x1C1...	
<PS>	CoE	0x1C13:00	0x03 (3)	download pdo 0x1C1...	
PS	CoE	0x8000:01	0x71 (113)	module code	
PS	CoE	0x8020:01	0x03 (3)	module code	
PS	CoE	0x8040:01	0x00 (0)	module code	
PS	CoE	0x2020:02	585	CR1: output mode set...	

Move Up Move Down New... Delete...

Click “TwinCAT” menu > “Activate Configuration” option to make current configuration effective. Refer to **DVP-PLC Application Manual: Special Modules** for details on CR1 in DVP04DA-S.

7.2.2 Controlling RTU-ECAT’s Right-side Modules via PLC

■ After the configuration of the entire network is finished by following the steps above, create the PLC program to control the modules on the right of RTU-ECAT.

1. Select “PLC” on the left list of the TwinCAT software, right click on “PLC” and select “Add New Item” to add a PLC project.

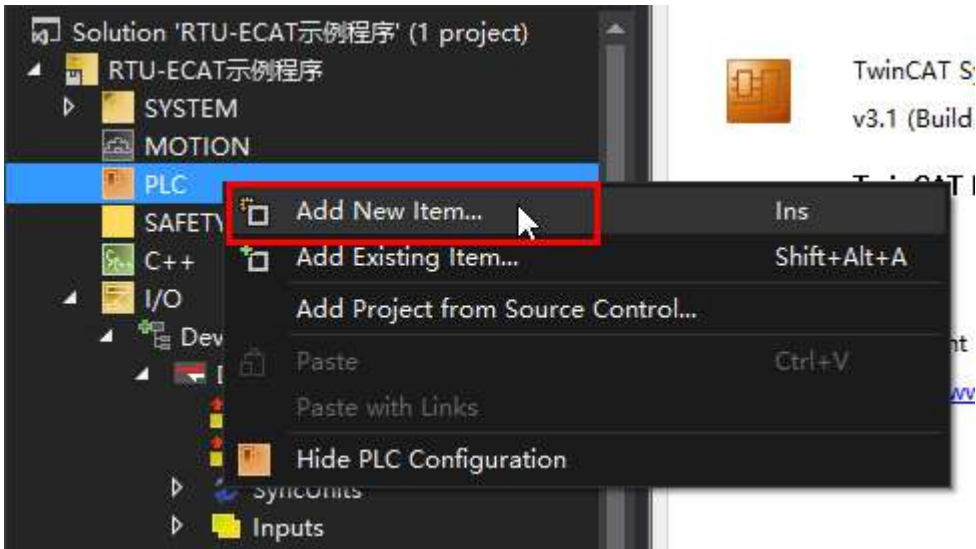

2. Select “Standard PLC Project” from the new PLC project list, enter a name for the project and then click on the “Add” button.

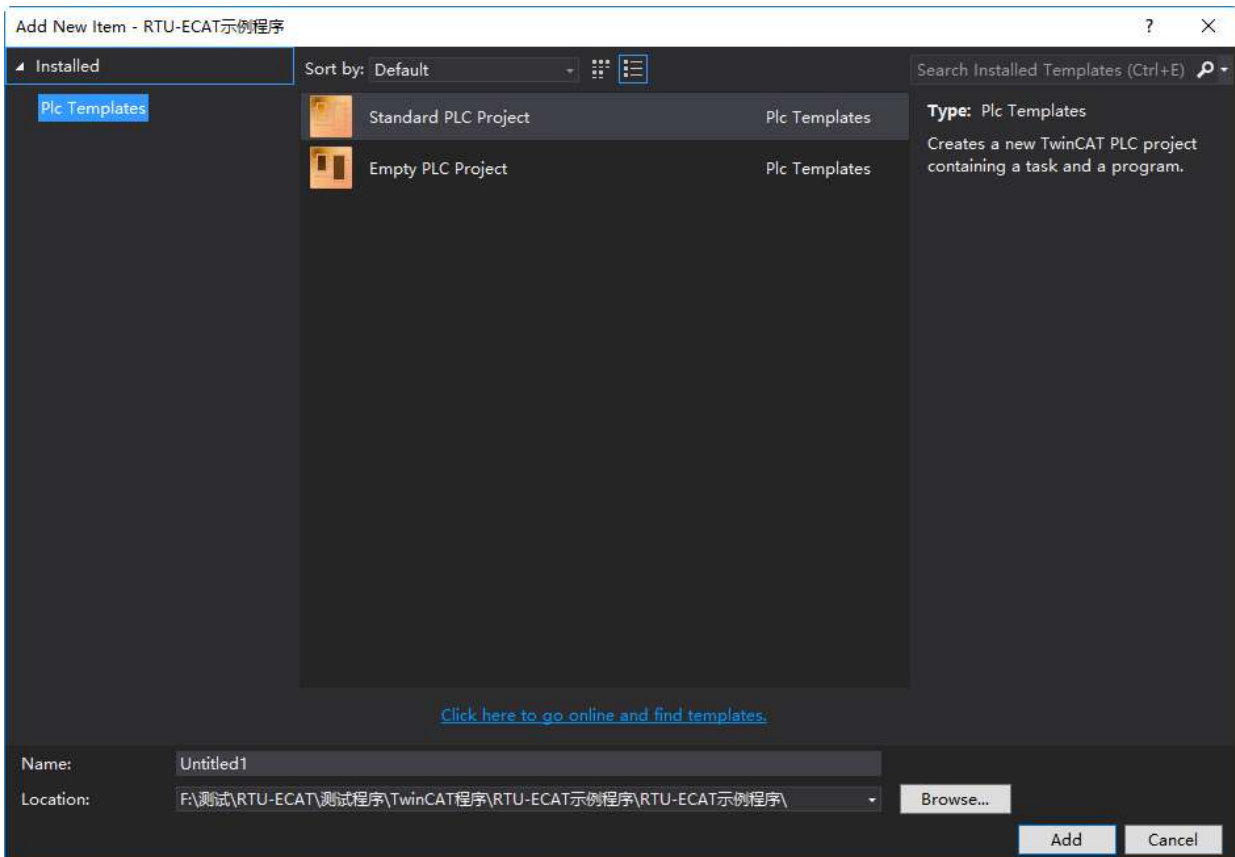

3. Create a global variable table in the PLC project and global variables as follows.

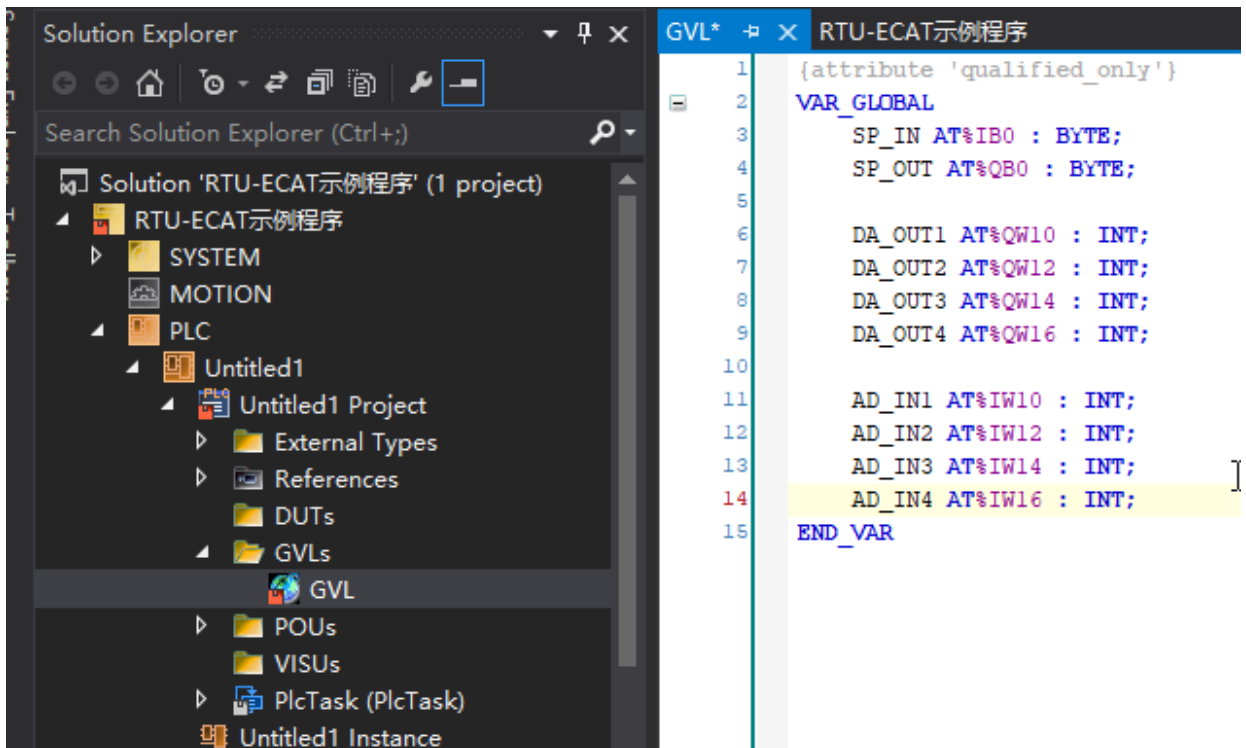

4. Click on “Build Solution” of “BUILD” menu to compile current project after global variables are created.
5. After the compiling is over, unfold the mapping list of RTU-ECAT’s right-side module with a click on it as below.

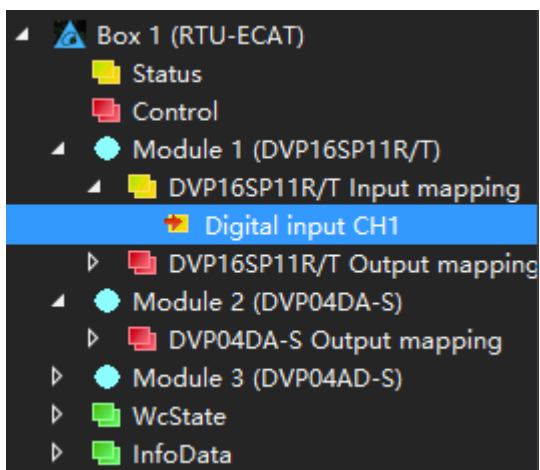

6. With a click on “Digital input CH1” above, the following window shows up, where you click on the “Linked to” button.

Variable	Flags	Online
Name:	Digital input CH1	
Type:	USINT	
Group:	DVP16SP11R/T Input mappi	Size: 1.0
Address:	39 (0x27)	User ID: 0
Linked to...		
Comment:		
ADS Info:	Port: 11, IGrp: 0x3040030, IOffs: 0x80000027, Len: 1	

With a click on “Linked to”, the following interface pops out, where you select desirable variables and then click on the “OK” button.

Attach Variable Digital input CH1 (Input)

Search:

- PLC
 - Untitled1
 - Untitled1 Instance
 - GVL.SP_IN > IB 128000.0, BYTE [1.0]**

Show Variables

Unused

Used and unused

Exclude disabled

Exclude other Devices

Exclude same Image

Show Tooltips

Sort by Address

Show Variable Groups

Show Variable Types

Matching Type

Matching Size

All Types

Array Mode

Offsets

Continuous

Show Dialog

Variable Name / Comment

/ Hand over

/ Take over

Cancel

7

Following the instructions of step 5 and step 6, make the connection between other global variables and the channels of DVP16SP11T, DVP04DA and DVP04AD.

The relations between global variables and RTU-ECAT 's right-side modules:

Input:				
SP_IN	←	RTU-ECAT	←	Read the state of input points of DVP16SP11T
AD_IN1	←		←	Read current value of channel1 of DVP04AD
AD_IN2	←		←	Read current value of channel2 of DVP04AD
AD_IN3	←		←	Read current value of channel3 of DVP04AD
AD_IN4	←		←	Read current value of channel4 of DVP04AD
Output:				
SP_OUT	→	RTU-ECAT	→	Control the output of output points of DVP16SP11T
DA_OUT1	→		→	Control the output of channel1 of DVP04DA
DA_OUT2	→		→	Control the output of channel2 of DVP04DA
DA_OUT3	→		→	Control the output of channel3 of DVP04DA
DA_OUT4	→		→	Control the output of channel4 of DVP04DA

7. After the variables and channels are connected, the values of channels of RTU-ECAT's right-side modules can be read through the variables in the program. Setting the value of SP_OUT to 255, Y0~Y7 outputs of DVP16SP11T all change into ON. Setting the values of DA_OUT1~DA_OUT4 to 2000, channel 1~channel 4 of DVP04DA-S can be controlled to output 5V voltage.

7.3 Using OMRON NJ301 with RTU-ECAT

1. Start the OMRON Sysmac Studio software and create a new project as below.

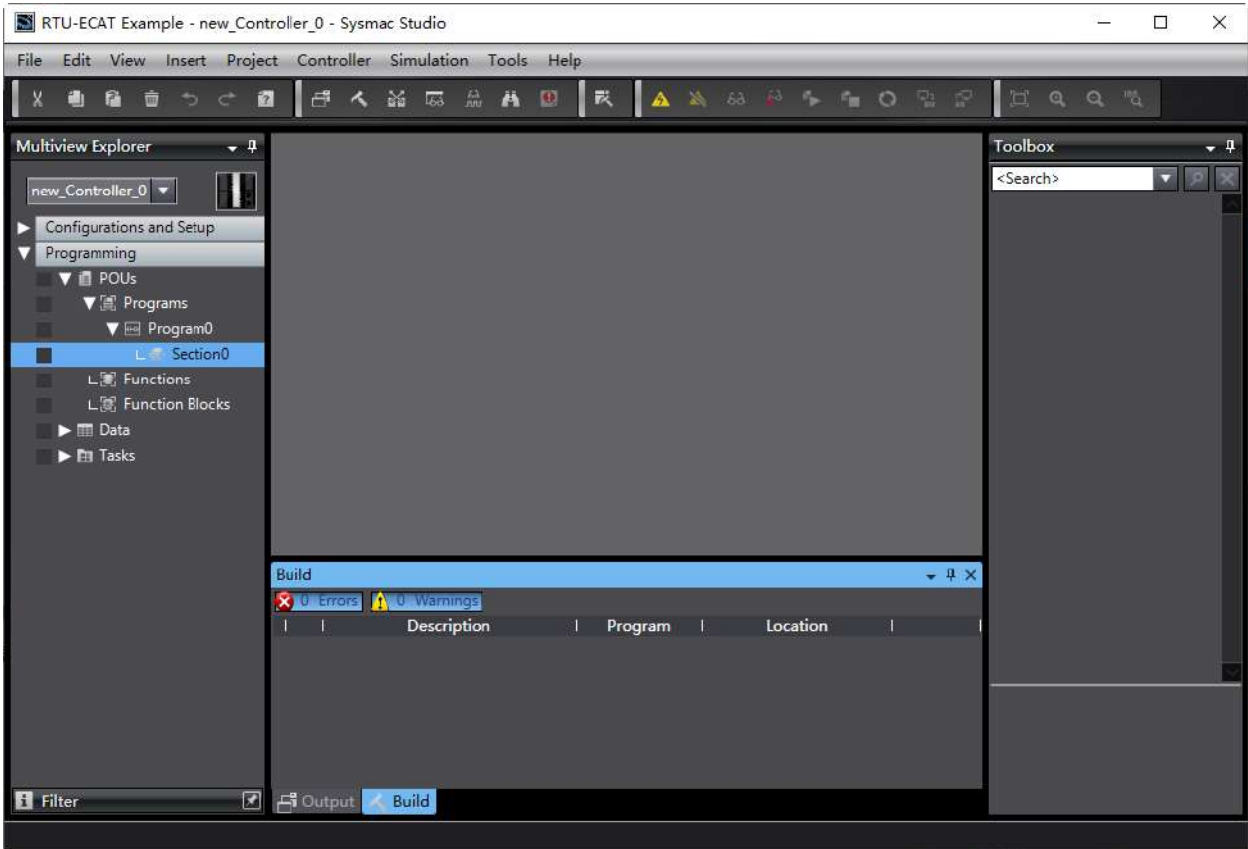

2. Double-click “EtherCAT” under “Configurations and Setup” in the red box below to open the EtherCAT configuration interface.

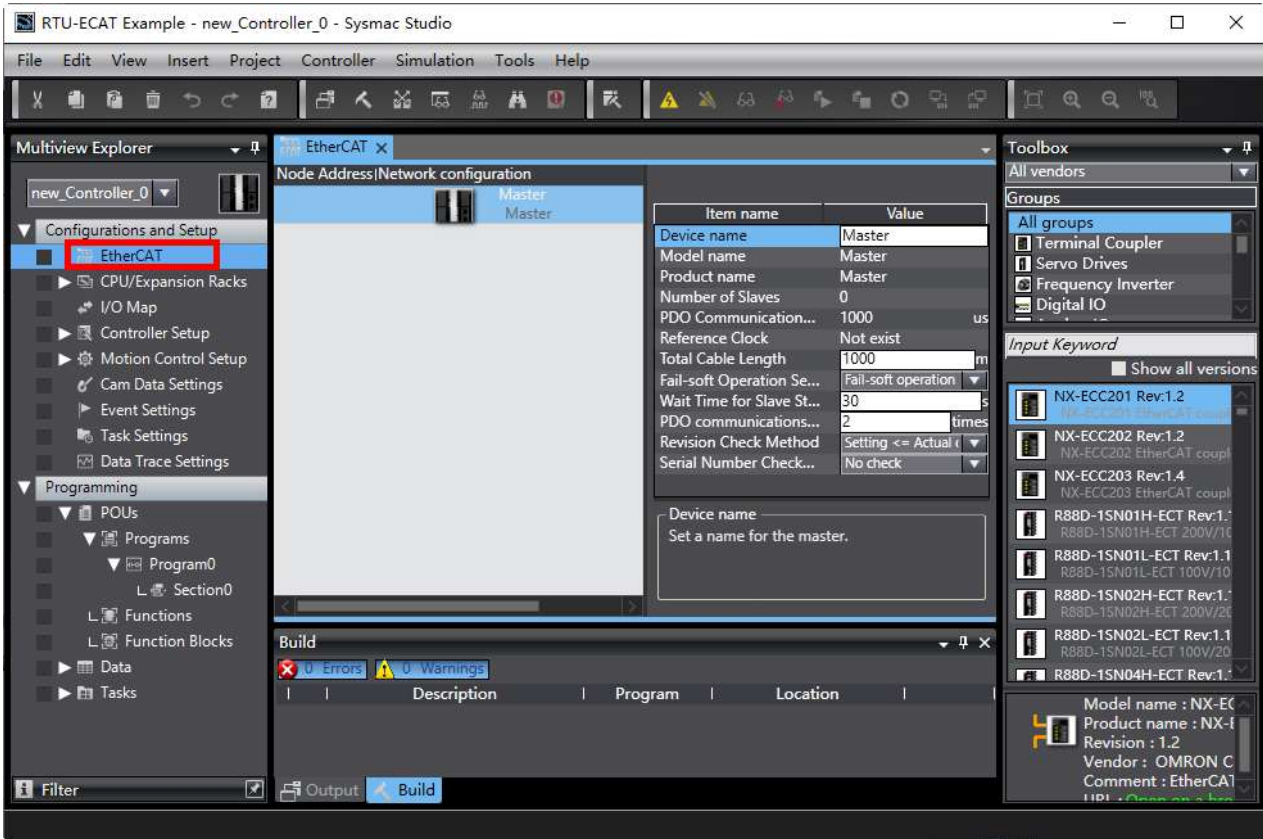

3. Right-click on “Master” and then select “Display ESI Library” from the context menu.

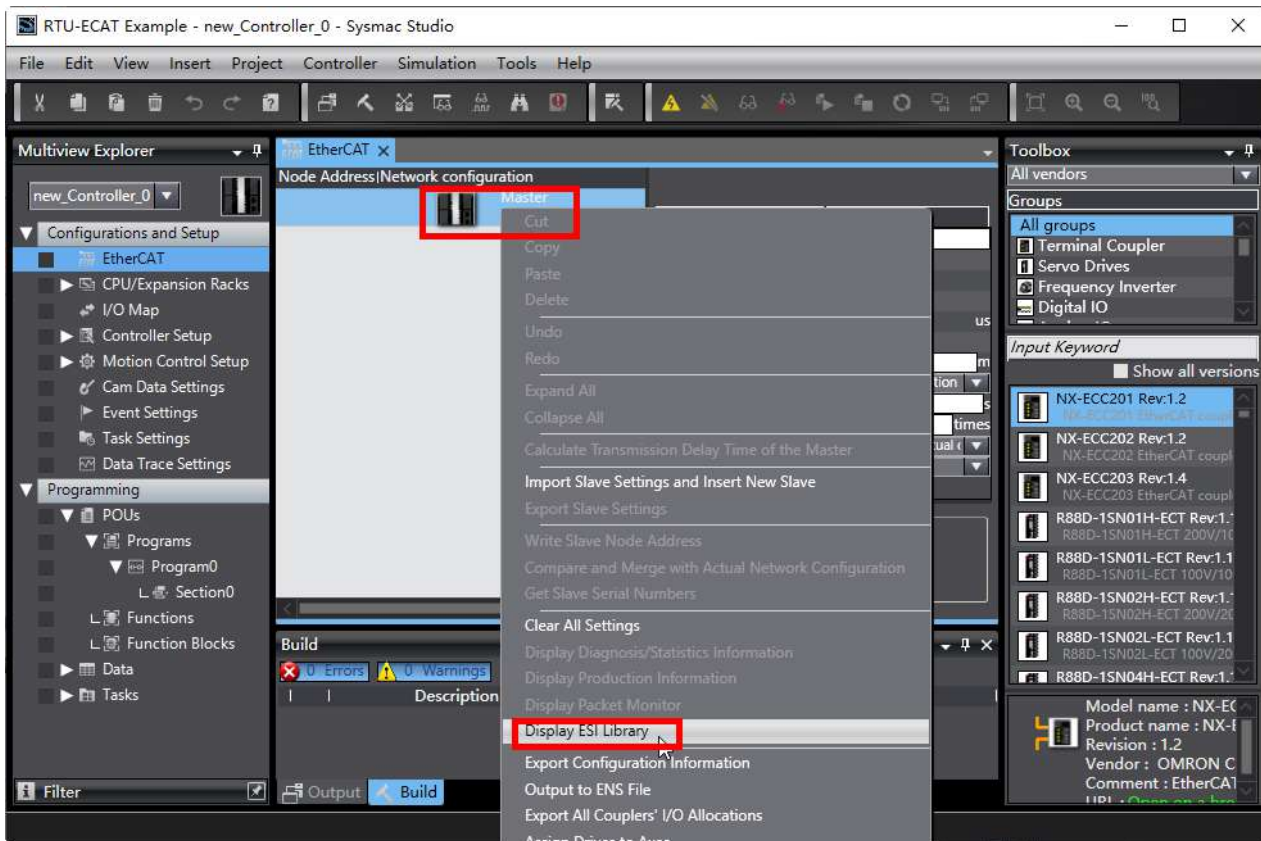

Click “this folder” in the red box in the ESI Library window to open the folder where ESI file is to be stored. Copy the ESI file of RTU-ECAT to this folder to complete the installation of RTU-ECAT device file.

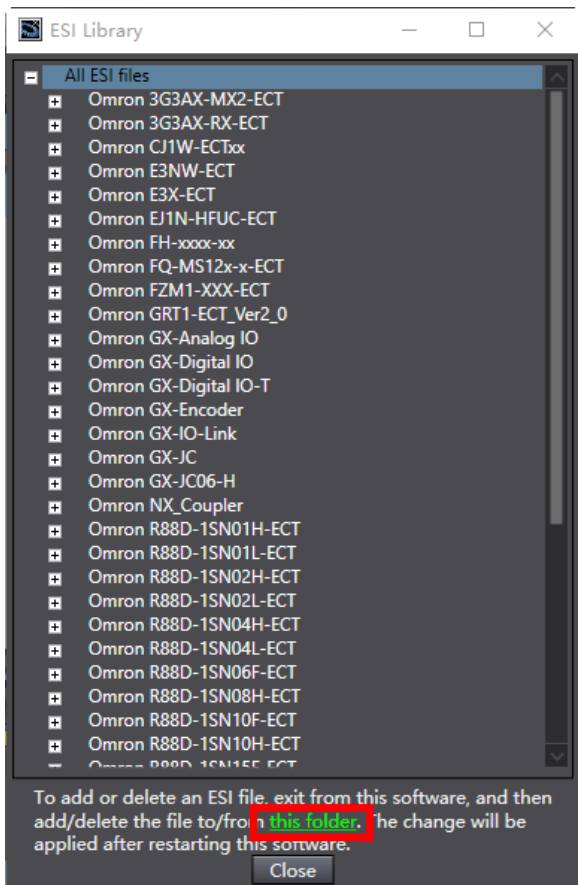

4. Select “Delta Electronics, Inc.” from the Toolbox pulldown list and then choose “EtherCAT PLC” as well as double-click on RTU-ECAT to add RTU-ECAT to the EtherCAT network.

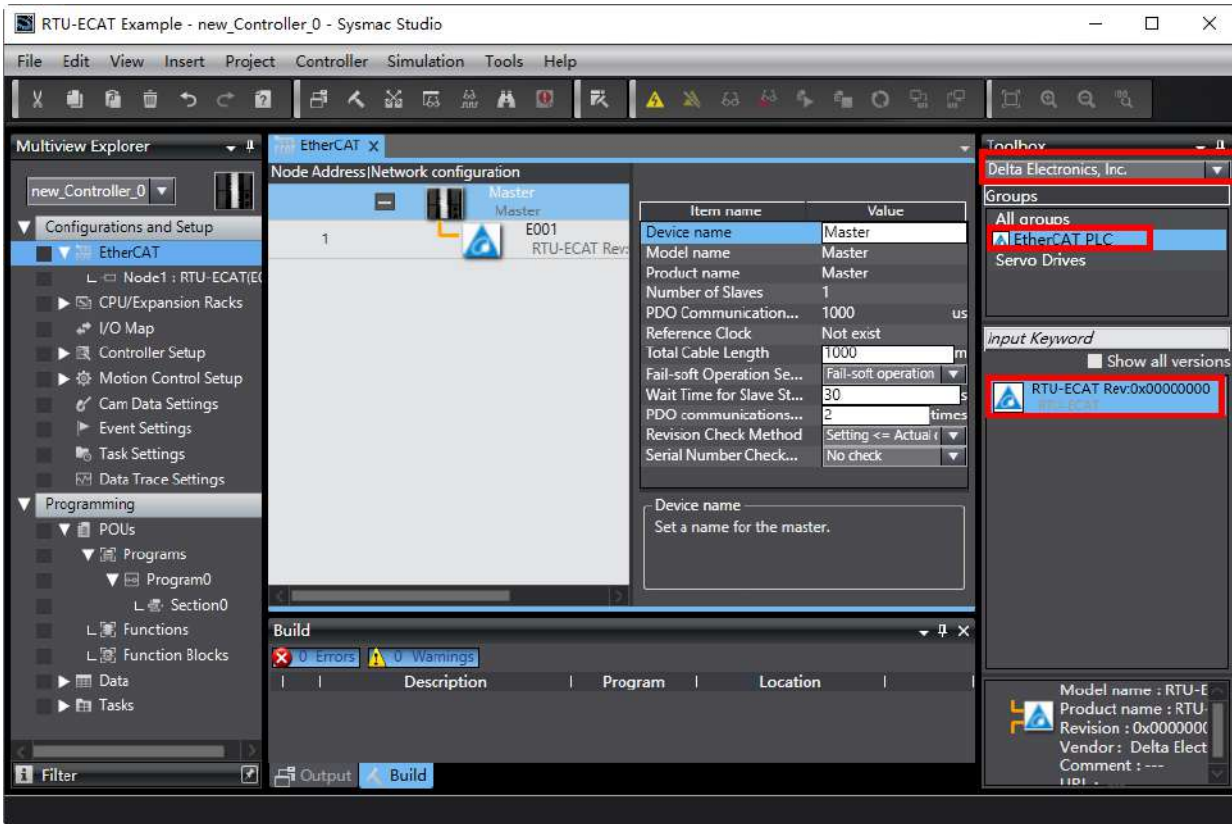

5. Double-click on “Node1: RTU-ECAT(E001)” to open the configuration interface after RTU-ECAT is added to the EtherCAT network.

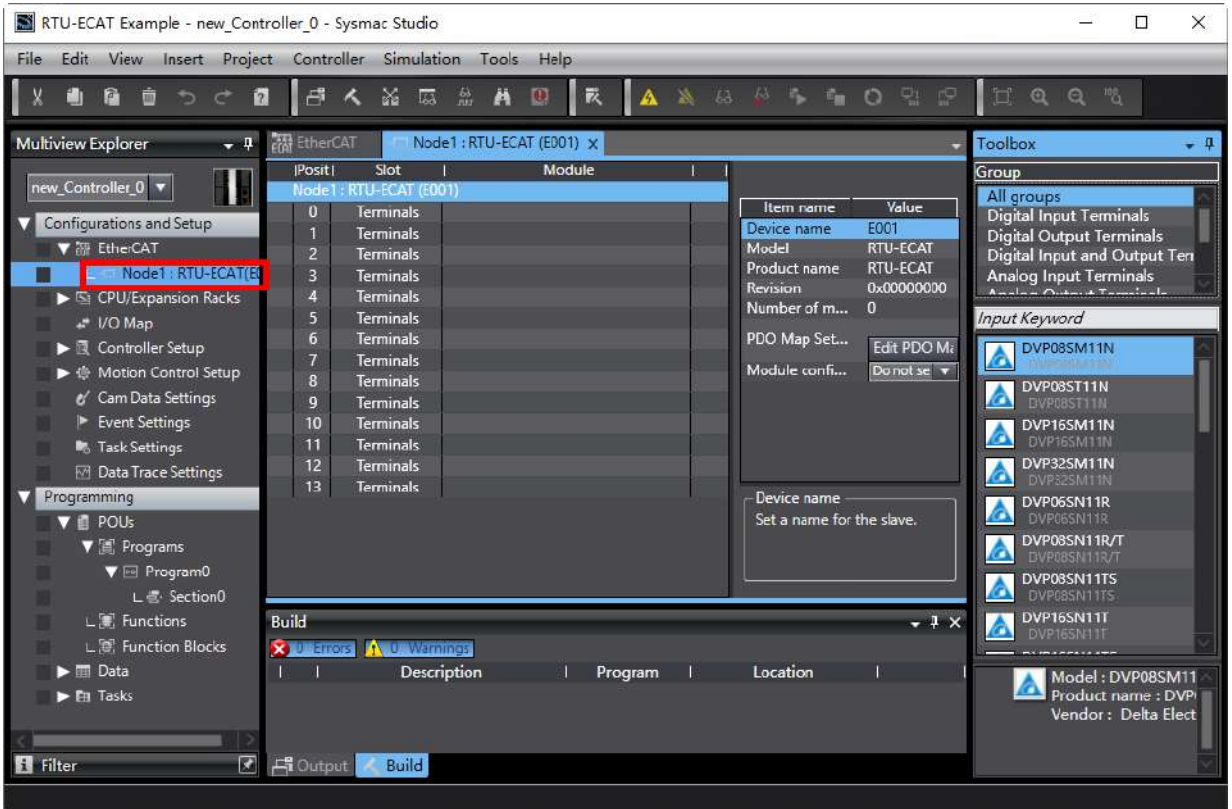

6. Add DVP16SP11T to the node configuration as below by selecting the top slot and then finding out and double-clicking on DVP16SP11R/T from the Toolbox area on the right side of the software.

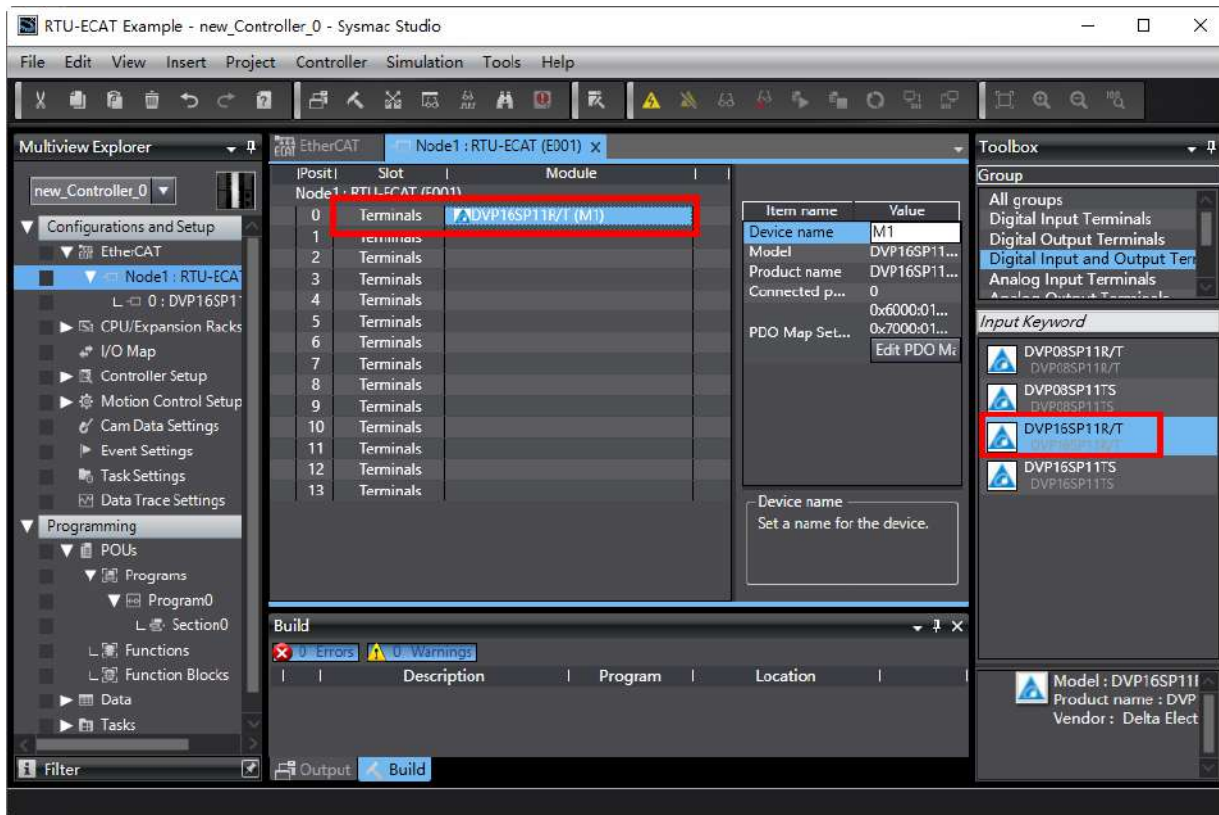

7. Add DVP04DA-S and DVP04AD-S to the second and third slots respectively in the method of step 6.

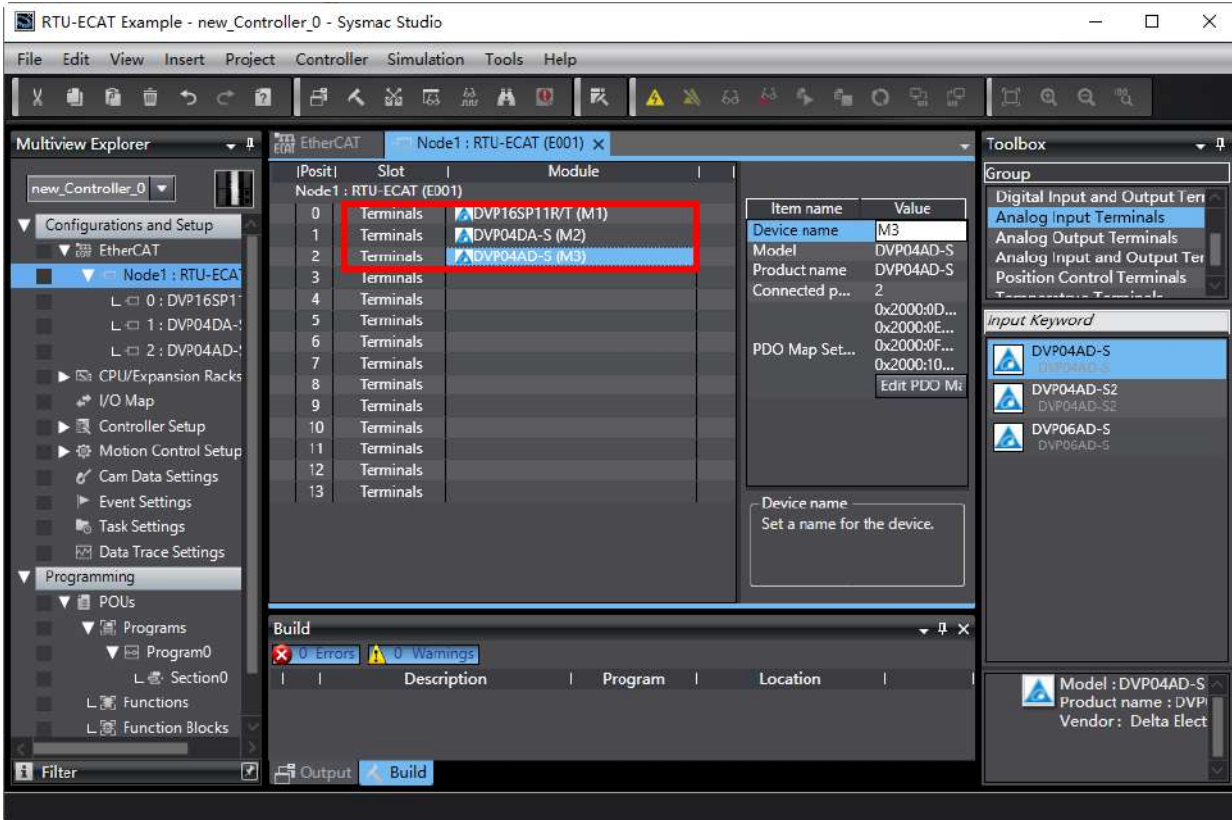

8. Double-click on "I/O Map" in the red box below and then type variables for mapping of module channels in the "Variable" column of the "IO Map" interface.

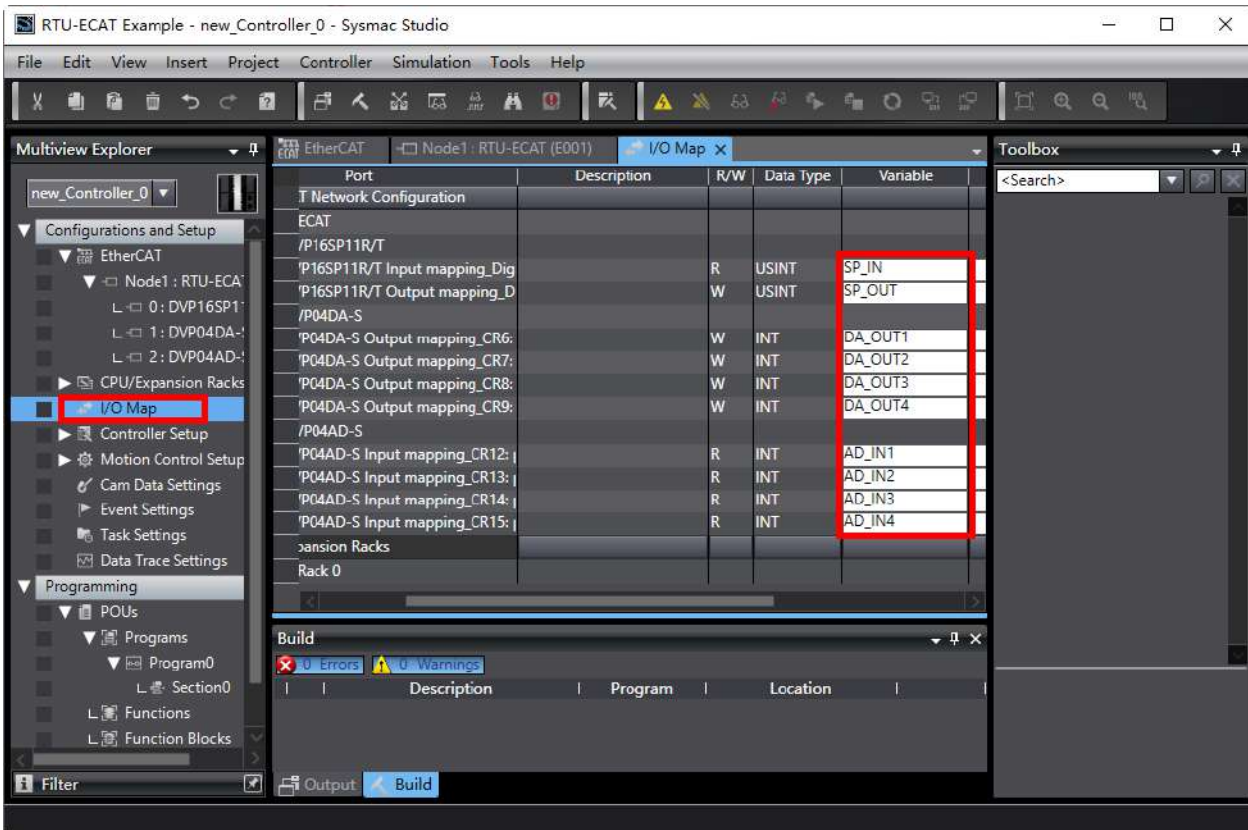

9. Click menu "Controller" > "Communications Setup..." to set up the connection type between the NJ CPU and computer as follows.

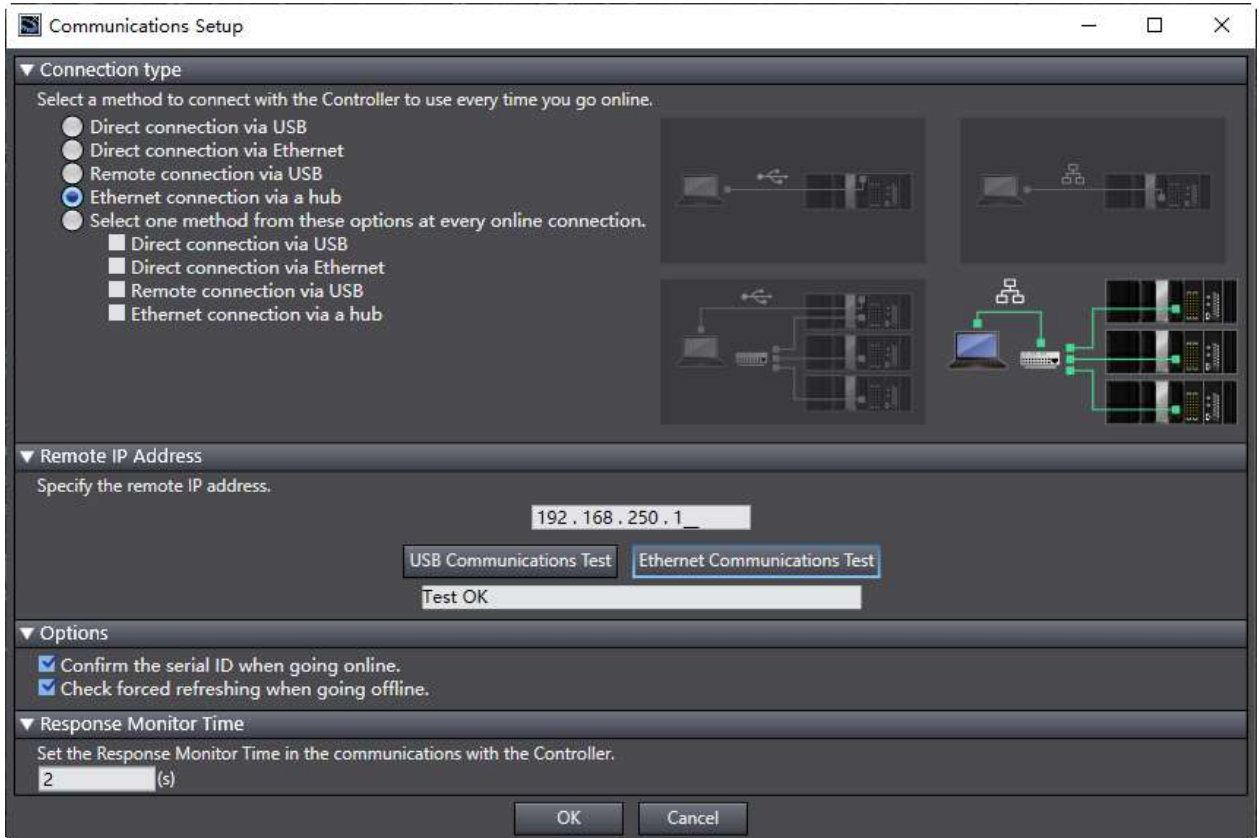

10. After the communication setup is complete, click “OK” button in the window above and then select “Online” from the “Controller” menu in the window below.

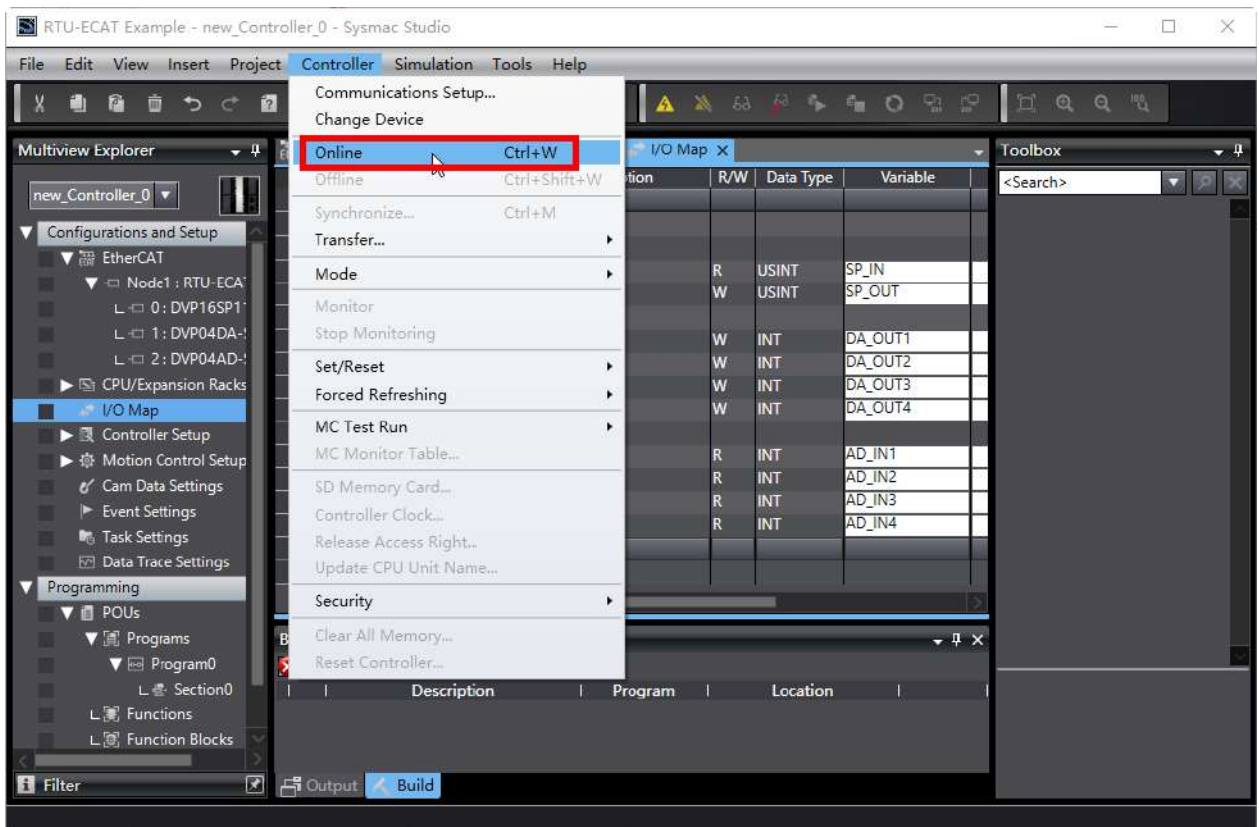

11. When going online is successful, click menu "Controller" > "Transfer..." > "To Controller..." to download the EtherCAT configuration and program to the controller. After the download is done, the channels of the right-side modules of RTU-ECAT can be read and written to via the variables set in the I/O Map interface.

Setting the value of SP_OUT to 255, Y0~Y7 outputs of DVP16SP11T all change into ON. Setting the values of DA_OUT1~DA_OUT4 to 2000, channel 1~ channel 4 of DVP04DA-S can be controlled to output 5V voltage.

Chapter 8 Error Diagnosis and Trouble-shooting

Table of Contents

8.1 LED Indicator Diagnosis.....	8-2
8.2 Status Indication Diagnosis	8-3

RTU-ECAT provides two diagnostic methods, LED indicator diagnosis and status indication diagnosis.

8.1 LED Indicator Diagnosis

POWER LED

LED status	Indication	How to correct
Off	Power is abnormal.	Make sure that RTU-ECAT is powered.
Green light on	Power is normal.	--

ALARM LED

LED status	Indication	How to correct
Off	RTU-ECAT works normally or lacks the work power.	--
Red light blinking	Possible causes: 1. The configuration data of RTU-ECAT are invalid; 2. The extension modules on the right of RTU-ECAT are in error or are offline.	1. Check if the modules on the right of RTU-ECAT are consistent with those configured in the software. 2. Check out the error information of the modules on the right of RTU-ECAT and then deal with the errors by following related module manual instructions. 3. Check if the power supply and wiring of the modules on the right of RTU-ECAT are fine. 4. Make sure that the wiring of EtherCAT cables is proper.
Red light on	RTU-ECAT is under voltage	Check if the power supply for RTU-ECAT is normal.

RUN LED

LED status	Indication	How to correct
Off	RTU-ECAT in STOP mode	1. Ensure that the power supply for RTU-ECAT and the connection are fine. 2. Check if the RUN/STOP switch of RTU-ECAT has been switched to RUN. 3. Check if the control word of RTU-ECAT is effective and controlling RTU-ECAT in STOP state.
Green light on	RTU-ECAT in RUN mode	--

EtherCAT LED

LED	LED status	Indication	How to correct
Green light	ON	The EtherCAT port has been connected to the EtherCAT network.	--
	OFF	The EtherCAT port has not yet been connected to the EtherCAT network.	Ensure that the hardware connection to the EtherCAT port is proper.
Yellow light	Blinking	Data are being transmitted or received via the EtherCAT port	--
	ON	No data are being transmitted or received via EtherCAT port.	Add RTU-ECAT to the master.
	OFF	There is no hardware connection to the EtherCAT port.	Ensure that the hardware connection to the EtherCAT port is proper.

8.2 Status Indication Diagnosis

The status indication parameters of RTU-ECAT are used to display the operating states of special modules and DI/DO modules. See section 6.3.2 for details on related status indication parameters.

MEMO



Appendix A List of Accessories

Table of Contents

A.1 Accessories for EtherCAT Communication	A-2
---	------------

A.1 Accessories for EtherCAT Communication

- Cables

Figure	Model	Length	Diameter (AWG)
	UC-EMC003-02A	0.3M	4#22 PVC
	UC-EMC005-02A	0.5M	4#22 PVC
	UC-EMC010-02A	1.0M	4#22 PVC
	UC-EMC020-02A	2.0M	4#22 PVC
	UC-EMC050-02A	5.0M	4#22 PVC
	UC-EMC100-02A	10.0M	4#22 PVC
	UC-EMC200-02A	20.0M	4#22 PVC

A