



# **RTU-EN01**

## ***Modbus TCP Remote I/O Communication Module***

### **Operation Manual**



<http://www.delta.com.tw/industrialautomation>



# Introduction

- ✓ This operation manual only provides introductory information on electrical specification, installation and wiring.
- ✓ RTU-EN01 is an OPEN-TYPE device and therefore should be installed in an enclosure free of airborne dust, humidity, electric shock and vibration. The enclosure should prevent non-maintenance staff from operating the device (e.g. key or specific tools are required to open the enclosure) in case danger and damage on the device may occur. DO NOT touch any terminal when the power is switched on.
- ✓ Please read this manual carefully and follow the instructions to avoid damage on the product or harm on staff.

## Table of Content

<b>1</b>	<b>INTRODUCTION</b>	<b>3</b>
1.1	Features	3
1.2	Specifications	3
<b>2</b>	<b>PRODUCT PROFILE &amp; OUTLINE</b>	<b>4</b>
2.1	Dimension	4
2.2	Product Profile	5
2.3	LED Indicators	5
2.4	RUN/STOP Switch	6
2.5	RJ-45 PIN Definition	6
2.6	RS-232 PIN Definition	6
2.7	RS-485 PIN Definition	6
<b>3</b>	<b>INSTALLATION &amp; WIRING</b>	<b>6</b>
3.1	Connecting RTU-EN01 to DVP Slim Series Digital Input/Output Module	6
3.2	Installing RTU-EN01 and DVP Slim Series Digital Input/Output Module onto DIN Rail	7
3.3	How to Connect RTU-EN01 to Network	7
<b>4</b>	<b>WORD DEVICES &amp; BIT DEVICES IN RTU-EN01</b>	<b>8</b>
4.1	Basic Registers (BR)	8
4.2	Explanations on BR	9
4.3	External Input Contacts (RX)	12
4.4	External Output Contacts (RY)	12
4.5	Control Register for Extension Modules (RCR)	12
4.6	Word Devices & Bit Devices for Timers (T)	13
4.7	Word Devices & Bit Devices for Counters (C)	14
4.8	Bit Devices for Real-Time Clock (R)	14
<b>5</b>	<b>MODBUS COMMUNICATION</b>	<b>15</b>
5.1	Function Codes Supported	15
5.2	Exception Codes Supported	15
5.3	Device Type & Device Address	16

<b>6</b>	<b>SETTING UP SOFTWARE</b> .....	<b>16</b>
6.1	Setting up Communications & Searching for Communication Modules in DCISoft .....	16
6.2	Recording IP Address .....	18
6.3	Basic Settings .....	19
6.4	Network Settings .....	21
6.5	Setting up Time Server .....	22
6.6	IP Filter .....	23
6.7	Smart PLC Setting: IF-THEN.....	24
6.8	Smart PLC Setting: Timer .....	25
6.9	Smart PLC Setting – Counter .....	25
6.10	Smart PLC Setting – RTC.....	26
6.11	Analog Input/Output Modules .....	27
6.12	I/O Monitoring Table.....	29
6.13	Setting up Gateway .....	30
6.14	Virtual COM .....	33
6.15	Security Setting .....	35
6.16	Returning to Default Settings.....	36
6.17	Web Function.....	36
<b>7</b>	<b>APPLICATION EXAMPLES – DCISOFT</b> .....	<b>42</b>
7.15	Smart PLC: IF-THEN .....	42
7.16	Smart PLC: Timer .....	43
7.17	Smart PLC: Counter .....	44
7.18	Smart PLC: RTC.....	45
7.19	Virtual COM .....	46

Microsoft® and Windows Internet Explorer® are the registered trade mark or trade mark of Microsoft Corporation in the United States and other countries.

Java® is the registered trade mark or trade mark of Sun Microsystems, Inc. in the United States or other countries.

The companies and products mentioned in this operation manual can be the trade mark possessed by the owner of that trade mark right.

## 1 Introduction

To ensure correct installation and operation of RTU-EN01, please read this manual carefully before using your RTU-EN01. RTU-EN01 is an Ethernet remote I/O module for remote setting through Delta's DCISoft. RTU-EN01 supports maximum 256 digital input/output points. RTU-EN01 supports Modbus TCP protocol and can be used for remote monitoring with graphic control software or human machine interface. RTU-EN01 can also be used as a Modbus TCP gateway, supporting the conversion from Modbus TCP commands to Modbus ASCII/RTU. In addition, in MDI/MDI-X auto-detect, jump wire is not needed when you choose the network cable.

### 1.1 Features

- Supporting smart PLC functions, counter, timer and real-time clock. Able to operate independently without control of PLC main processing unit or programming.
- Able to auto-detect 10/100 Mbps transmission speed; MDI/MDI-X auto-detect.
- Supporting maximum 16 digital input/output modules (Max. 256 I/O points) and 8 analog input/output modules.
- Supporting maximum 16 sets of Modbus TCP connections.
- Supporting Modbus TCP/Modbus gateway (supporting Master mode, connectable to maximum 32 devices).
- Parameters can be set up on webpage.

### 1.2 Specifications

#### ■ Ethernet interface

Interface	RJ-45 with Auto MDI/MDIX
Transmission method	802.3, 802.3u
Transmission cable	Category 5e, 100m (Max)
Transmission speed	10/100 Mbps Auto-Detection
Communication protocol	ICMP, IP, TCP, UDP, DHCP, NTP, Modbus TCP, HTTP

#### ■ Serial communication interface (COM1)

Interface	Mini Dim
Transmission method	RS-232
Communication speed	19,200 bps
Communication format	Stop bit: 1; Parity bit: None; Data bit: 8
Communication protocol	Delta Configuration
Transmission cable	DVPACAB215 / DVPACAB230 / DVPACAB2A30

#### ■ Serial communication interface (COM2)

Interface	3 PIN feed-through terminal
Transmission method	RS-485
Transmission distance	1,200m
Communication speed	110, 150, 300, 600, 1,200, 2,400, 4,800, 9,600, 19,200, 38,400, 57,600, 115,200 bps
Communication format	Stop bit: 1, 2; Parity bit: None, Odd, Even; Data bit: 7, 8
Communication protocol	Modbus ASCII · Modbus RTU

## ■ Environment

Noise immunity	ESD (IEC 61131-2, IEC 61000-4-2): 8KV Air Discharge EFT (IEC 61131-2, IEC 61000-4-4): Power Line:±2KV, Digital Input: ±2KV, Communication I/O: ±2KV RS (IEC 61131-2, IEC 61000-4-3): 80MHz ~ 100MHz, 10V/m. 1.4GHz ~ 2.0GHz, 10V/m Conducted Susceptibility Test (EN61000-4-6, IEC61131-2 9.10): 150kHz ~ 80MHz, 3V/m Surge Test (Biwave IEC61132-2, IEC61000-4-5): Power line 0.5KV DM, Ethernet 0.5KV CM, RS-485 0.5KV CM
Operation	0°C ~ 55°C (temperature), 50 ~ 95% (humidity), pollution degree 2
Storage	-25°C ~ 70°C (temperature), 5 ~ 95% (humidity)
Shock/vibration immunity	International standards: IEC61131-2, IEC 68-2-6 (TEST Fc)/IEC61131-2 & IEC 68-2-27 (TEST Ea)
Certificates	

## ■ Electrical specification

Power supply voltage	24VDC (-15% ~ 20%) (with DC input polarity reverse protection)
Power fuse capacity	1.85A/30VDC, Polyswitch
Power consumption	2W
Insulation voltage	500VDC
Weight	116g

## 2 Product Profile & Outline

### 2.1 Dimension

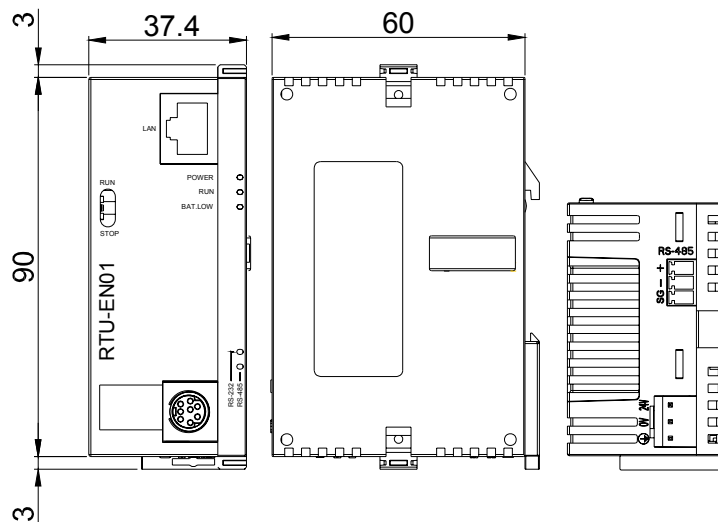

Unit: mm

## 2.2 Product Profile

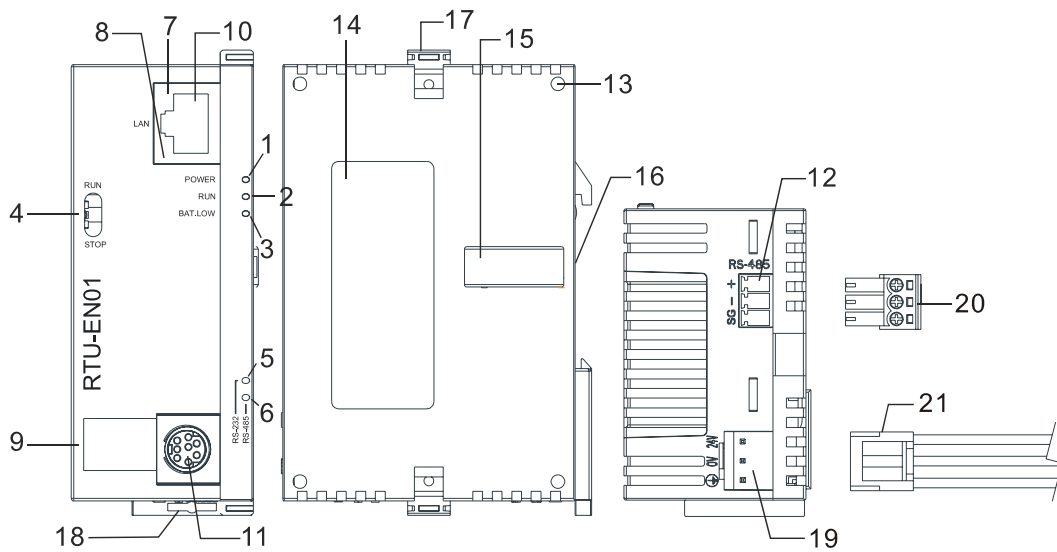

1. POWER indicator	12. RS-485 communication port
2. RUN indicator	13. Extension module positioning hole
3. BAT.LOW indicator	14. Nameplate
4. RUN/STOP switch	15. Extension port
5. RS-232 indicator	16. DIN rail (35mm)
6. RS-485 indicator	17. Extension module fixing clip
7. LINK/ACK indicator	18. DIN rail clip
8. SPEED indicator	19. Power supply port
9. Digital display	20. 3P terminal block (standard accessory)
10. Ethernet communication port	21. Power supply connection cable (standard accessory)
11. RS-232 communication port	

## 2.3 LED Indicators

LED	Color	Function
POWER	Green	Power supply indication
RUN	Green	RUN/STOP indication
BAT.LOW	Red	Battery in low power indication
RS-232	Yellow	Displaying communication status of RS-232 port
RS-485	Yellow	Displaying communication status of RS-485 port
LINK/ACT	Green	Displaying the status of network
SPEED	Yellow	Displaying the speed of network connection

## 2.4 RUN/STOP Switch

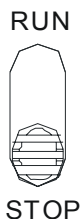

Status	Explanation
RUN	1. RUN indicator on RTU-EN01 is ON.
	2. Analog input/output module is in RUN status.
	3. Smart PLC function is running.
RUN → STOP	1. Analog input/output module switches from RUN to STOP status.
	2. Y points on digital input/output module are all OFF.
STOP	1. RUN indicator on RTU-EN01 is OFF.
	2. Analog input/output module is in STOP status.
	3. Smart PLC function stops.
STOP → RUN	1. RTU-EN01 re-detects the information on the right-side module.
	2. Analog input/output module switches from STOP to RUN status.

## 2.5 RJ-45 PIN Definition

PIN	Signal	Definition	PIN	Signal	Definition
1	Tx+	Positive pole for data transmission	5	--	N/C
2	Tx-	Negative pole for data transmission	6	Rx-	Negative pole for data receiving
3	Rx+	Positive pole for data receiving	7	--	N/C
4	--	N/C	8	--	N/C

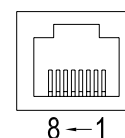

## 2.6 RS-232 PIN Definition

PIN	Signal	Definition	PIN	Signal	Definition
1	--	N/C	5	Tx	Transmission data
2	--	N/C	6	--	N/C
3	--	N/C	7	--	N/C
4	Rx	Reception data	8	GND	Ground

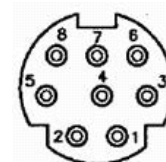

## 2.7 RS-485 PIN Definition

PIN	Signal	Definition
1	SG	Ground of data
2	D-	Negative pole for data
3	D+	Positive pole for data



## 3 Installation & Wiring

In this section, we will introduce how to connect RTU-EN01 to other devices and the network.

### 3.1 Connecting RTU-EN01 to DVP Slim Series Digital Input/Output Module

- Open the fixing clips on the right top and bottom sides on RTU-EN01. Meet the extension port on RTU-EN01 and the digital input/output module.
- Press and fix the clips on the digital input/output module. Make sure the contact between the modules is fine.



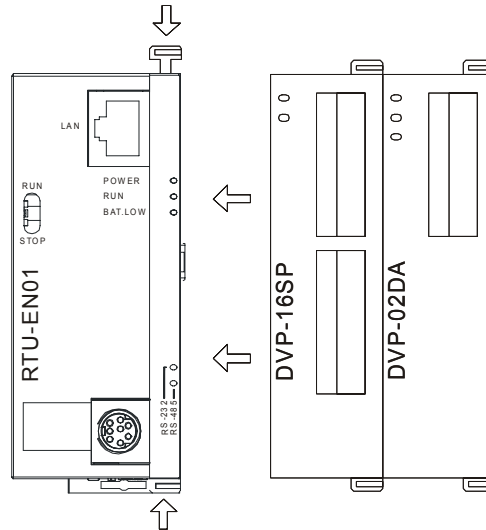

### 3.2 Installing RTU-EN01 and DVP Slim Series Digital Input/Output Module onto DIN Rail

- Use standard 35mm DIN rail.
- Open the DIN rail clips on RTU-EN01 and the digital input/output module and insert the modules onto the rail.
- Press the clips to fix the modules onto the rail.

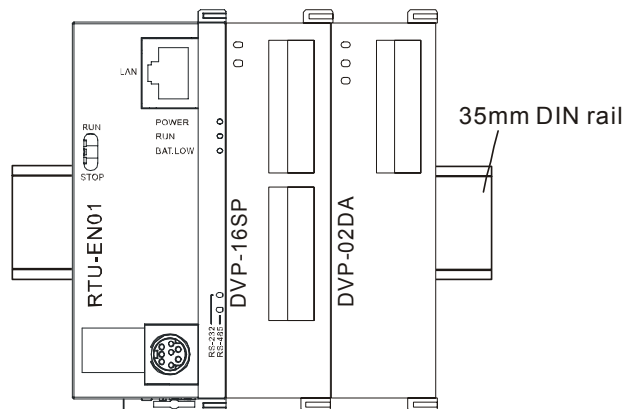

### 3.3 How to Connect RTU-EN01 to Network

Connect RTU-EN01 to the Ethernet hub by CAT-5e twisted pair. Since RTU-EN01 has Auto MDI/MDIX function, CAT-5e twisted pair does not need to jump wire. See below for the connection between the PC and RTU-EN01 modules:

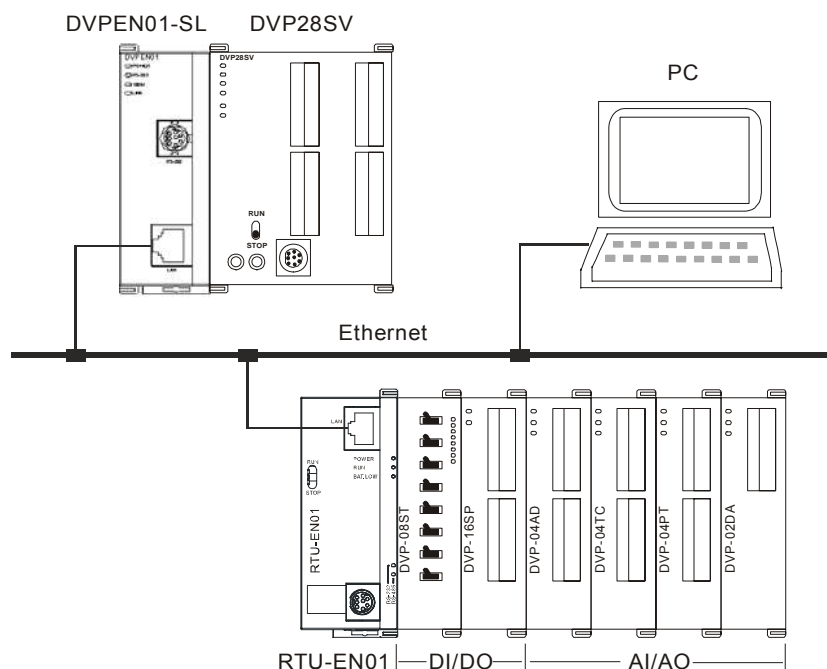

## 4 Word Devices & Bit Devices in RTU-EN01

### 4.1 Basic Registers (BR)

BR#	Attribute	Content	Explanation	Default	Latched
0	R	Model name	Set up by the system; read only. The model code of RTU-EN01= H'0600.	H'0600	YES
1	R	Firmware version	Displaying the current firmware version in hex, e.g. V1.2 is indicated as high byte = 0x01 and low byte = 0x20.		YES
2	R	Release date of the version	Displaying the data in decimal form. 10,000s digit and 1,000s digit are for "month"; 100s digit and 10s digit are for "day". For 1s digit: 0 = morning; 1 = afternoon.  Example: 12191 indicates the version released in the afternoon of December 19.		YES
3	R/W	Start/Stop PLC function			NO
4		Reserved	.		NO
5	R/W	COM2 communication settings	RS-485 communication settings. Please refer to the table of baud rate setting and communication format setting.	H'0368	YES
6	R/W	Address	For setting up the station address	K'1	YES
7	R	Number of DI points	Range: 0 ~ 256		NO
8	R	Number of DO points	Range: 0 ~ 256		NO
9	R	Error code	Displaying the errors. Please refer to the table of error codes.		NO
10		Reserved			NO
11	R/W	Communication time-out	For setting up the communication time-out (ms) in Modbus TCP mode.	K'5000	YES
12	R/W	Communication delay time	For setting up the minimum interval time between every communication datum.	K'0	YES
13	R/W	TCP connection idle time	For setting up idle time for TCP communication. Unit: second	K'30	YES
14 ~ 22		Reserved			NO
23	R	Number of analog I/O modules	Max. 8		NO

BR#	Attribute	Content	Explanation	Default	Latched
24	R	ID of the 1st analog I/O module	ID of the 1st analog I/O module		NO
25	R	ID of the 2nd analog I/O module	ID of the 2nd analog I/O module		NO
26	R	ID of the 3rd analog I/O module	ID of the 3rd analog I/O module		NO
27	R	ID of the 4th analog I/O module	ID of the 4th analog I/O module		NO
28	R	ID of the 5th analog I/O module	ID of the 5th analog I/O module		NO
29	R	ID of the 6th analog I/O module	ID of the 6th analog I/O module		NO
30	R	ID of the 7th analog I/O module	ID of the 7th analog I/O module		NO
31	R	ID of the 8th analog I/O module	ID of the 8th analog I/O module		NO
32 ~ 49		Reserved			NO
50	R/W	RTC settings	Settings of the real-time clock		NO
51	R/W	Year	Range: 1970 ~ 2099		YES
52	R/W	Week	Range: 1 ~ 7		YES
53	R/W	Month	Range: 1 ~ 12		YES
54	R/W	Day	Range: 1 ~ 31		YES
55	R/W	Hour	Range: 0 ~ 23		YES
56	R/W	Minute	Range: 0 ~ 59		YES
57	R/W	Second	Range: 0 ~ 59		YES
58 ~ 59		Reserved			NO
60		Reserved			NO
61 ~ 63		Reserved		0	NO

Symbol "R" refers to ready only; "R/W" refers to read and write.

#### 4.2 Explanations on BR

##### **BR#0: Model Name**

Explanations:

1. Model code of RTU-EN01 = H'0600.
2. You can read the model code in the program to see if the extension module exists.

##### **BR#1: Firmware Version**

Explanations:

The firmware version of RTU-EN01 is displayed in hex, e.g. H'0100 indicates version V1.00

##### **BR#2: Release Date of the Version**

Explanations:

Displaying the data in decimal form. 10,000s digit and 1,000s digit are for "month"; 100s digit and 10s digit are for "day". For 1s digit: 0 = morning; 1 = afternoon.

Example: 12191 indicates the version released in the afternoon of December 19.

## BR#5: COM2 Communication Settings

Explanations:

b0 ~ b3									
Content	Interface	Explanation							
	COM2 RS-485	Data	Baud rate (bps)	Data	Baud rate (bps)	Data	Baud rate (bps)	Data	Baud rate (bps)
		0x1	110	0x6	2,400	0xB	57,600		
		0x2	150	0x7	4,800	0xC	115,200		
		0x3	300	0x8	9,600				
		0x4	600	0x9	19,200				
		0x5	1,200	0xA	38,400				
b4 ~ b7									
Explanation	b7		b6 ~ b5			b4			
	Stop bit 0: 1 Stop bit 1: 2 Stop bits		Parity bit 00 : None parity bit 01 : Odd parity bit 11 : Even parity bit			Data bit 0 : 7 Data bits 1 : 8 Data bits			
	0000 (0)	7-N-1	0011 (3)	8-O-1	1000 (8)	7-N-2	1011 (B)	8-O-2	
	0001 (1)	8-N-1	0110 (6)	7-E-1	1001 (9)	8-N-2	1110 (E)	7-E-2	
0010 (2)	7-O-1	0111 (7)	8-E-1	1010 (A)	7-O-2	1111 (F)	8-E-2		
b8 ~ b15									
Content	Explanation								
0x02	Modbus RTU Master								
0x03	Modbus ASCII Master								

## BR#6: Address

Explanations

For filling in or reading the Modbus address. The address will be displayed in the message display after being set up. Range: 1 ~ 247.

## BR#7: Number of DI Points

Explanations

Read the number of digital input points from BR#7. Range: 0 ~ 256. Max. I/O points: 256.

## BR#8: Number of DO Points

Explanations

Read the number of digital output points from BR#8. Range: 0 ~ 256. Max. I/O points: 256.

## BR#9: Error Code

Explanations:

Error code = 0 refers to no error occurring.

Code	Indication	How to correct
------	------------	----------------

Code	Indication	How to correct
F0	Returning to default setting	--
F1	RTU-EN01 being powered	--
F2	Power supply in low voltage	Check if the power supply of the module works normally.
F3	Internal error. Manufacturing error.	<ol style="list-style-type: none"> <li>1. Check if the settings of smart PLC are incorrect.</li> <li>2. Re-power RTU-EN01. If the error still exists, try step 3.</li> <li>3. Reset RTU-EN01. If the error still exists, send the module back to the manufacturer for repair.</li> </ol>
F5	Network connection error	Check if RTU-EN01 is connected normally to the network.
F6	Insufficient TCP connection	Check if the number of connected modules exceeds the maximum.
F7	RS-485 setting error	Check if the RS-485 communication format is correct.
F8	IP setting error	<ol style="list-style-type: none"> <li>1. DHCP request failure.</li> <li>2. IP setting error.</li> <li>3. MASK setting error.</li> <li>4. Gateway does not exist in the same subnet.</li> <li>5. Returning to default setting.</li> </ol>
F9	Right-side module error	Check if the configuration of the right-side module has been modified. If the error still exists, check if the number of I/O points exceeds the maximum and whether there are more than 8 analog I/O modules connected.
04	Slave error	1. Check if RTU-EN01 and RS-485 is connected normally.
0b	No response from station	2. Check if the series transmission speed is consistent with that of other nodes on the network.

### BR#11: Communication Time-out (ms)

Explanations:

For setting up the communication time-out. Default = 5,000ms. For example, if you wish to set up the communication time-out to 7 seconds manually, write 7000 to BR#11. Range: 5 ~ 65,535.

### BR#12: Communication Delay Time (ms)

Explanations:

For setting up the minimum interval time between every Modbus command. Default = 0ms. For example, if you wish to set up the communication delay time to 100ms manually, write 100 into BR#12. Range: 0 ~ 65,535.

### BR#13: TCP Connection Idle Time (s)

Explanations:

For setting up the TCP connection idle time. Default = 30 seconds. For example, if you wish to set up the idle time to 7 seconds manually, write 7 into BR#13. Range: 5 ~ 65,535.

### BR#23: Number of Analog I/O Modules

Explanations:

Read the number of right-side modules from BR#23. Max. 8.

### BR#24 ~ #31: ID of the 1<sup>st</sup> ~ 8<sup>th</sup> Analog I/O Module

Explanations:

Read the ID of the 1<sup>st</sup> ~ 8<sup>th</sup> analog I/O modules from BR#24 ~ BR#31.

## BR#50 ~ BR#57: RTC Settings

Explanations:

For setting up the real-time clock (RTC). When BR#9 = 1, RTU-EN01 will stop to update the RTC values to BR#10 ~ #16. Once the setup is completed, RTU-EN01 will set BR#9 to 0.

Allowed range for RTC: 1970/01/01 00:00:00 ~ 2037/12/31 23:59:59

BR#9	
0	No action
1	RTC stops
2	RTC being set

### 4.3 External Input Contacts (RX)

RX#	Attribute	Content	Explanation	Default	Latched
0 ~ 255	R/W	External input contact	Input points on analog I/O module	OFF	NO

Symbol "R" refers to ready only; "R/W" refers to read and write.

## RX#0 ~ #255: External Input Contact

Explanations:

The right-side extension interface on RTU-EN01 is able to connect to DVP-Slim series digital I/O modules. RTU-EN01 supports maximum 256 I/O points.

### 4.4 External Output Contacts (RY)

RY#	Attribute	Content	Explanation	Default	Latched
0 ~ 255	R/W	External output contact	Output points on analog I/O module	OFF	NO

Symbol "R" refers to ready only; "R/W" refers to read and write.

## RY#0 ~ #255: External Output Contact

Explanations:

The right-side extension interface on RTU-EN01 is able to connect to DVP-Slim series digital I/O modules. RTU-EN01 supports maximum 256 I/O points.

### 4.5 Control Register for Extension Modules (RCR)

RCR#	Attribute	Content	Explanation	Default	Latched
0 ~ 49	R/W	The 1 <sup>st</sup> analog I/O module	Control register for the 1 <sup>st</sup> analog I/O module	--	NO
50 ~ 99	R/W	The 2 <sup>nd</sup> analog I/O module	Control register for the 2 <sup>nd</sup> analog I/O module	--	NO
100 ~ 149	R/W	The 3 <sup>rd</sup> analog I/O module	Control register for the 3 <sup>rd</sup> analog I/O module	--	NO
150 ~ 199	R/W	The 4 <sup>th</sup> analog I/O module	Control register for the 4 <sup>th</sup> analog I/O module	--	NO

RCR#	Attribute	Content	Explanation	Default	Latched
200 ~ 249	R/W	The 5 <sup>th</sup> analog I/O module	Control register for the 5 <sup>th</sup> analog I/O module	--	NO
250 ~ 299	R/W	The 6 <sup>th</sup> analog I/O module	Control register for the 6 <sup>th</sup> analog I/O module	--	NO
300 ~ 349	R/W	The 7 <sup>th</sup> analog I/O module	Control register for the 7 <sup>th</sup> analog I/O module	--	NO
350 ~ 399	R/W	The 8 <sup>th</sup> analog I/O module	Control register for the 8 <sup>th</sup> analog I/O module	--	NO

Symbol "R" refers to ready only; "R/W" refers to read and write.

### RCR#0 ~ #399: Control Register for Right-Side Analog I/O Modules

Explanations:

By reading/writing RCR in RTU-EN01, you are able to store or retrieve the data in the control register (CR) inside the analog input/output module.

**Example:** RCR#0 corresponds to CR#0 in the 1<sup>st</sup> analog I/O module. RCR#260 corresponds to CR#10 in the 6<sup>th</sup> analog I/O module. Extension module closest to RTU-EN01 is regarded the 1<sup>st</sup> module.

#### 4.6 Word Devices & Bit Devices for Timers (T)

T#	Attribute	Register/coil name	Explanation	Default	Latched
0	R/W	Timer 0	Timer	0/OFF	NO
1	R/W	Timer 1	Timer	0/OFF	NO
2	R/W	Timer 2	Timer	0/OFF	NO
3	R/W	Timer 3	Timer	0/OFF	NO
4	R/W	Timer 4	Timer	0/OFF	NO
5	R/W	Timer 5	Timer	0/OFF	NO
6	R/W	Timer 6	Timer	0/OFF	NO
7	R/W	Timer 7	Timer	0/OFF	NO
8	R/W	Timer 8	Timer	0/OFF	NO
9	R/W	Timer 9	Timer	0/OFF	NO
10	R/W	Timer 10	Timer	0/OFF	NO
11	R/W	Timer 11	Timer	0/OFF	NO
12	R/W	Timer 12	Timer	0/OFF	NO
13	R/W	Timer 13	Timer	0/OFF	NO
14	R/W	Timer 14	Timer	0/OFF	NO
15	R/W	Timer 15	Timer	0/OFF	NO

Symbol "R" refers to ready only; "R/W" refers to read and write.

### T#0: Timer 0

Explanations:

When the timer is enabled, it will start to time according to the settings. When the timing reaches the target, the bit device T0 will be ON. When the bit device is reset, the word device will be reset to 0 as well.

## T#1 ~ #15: Timer 1 ~ 15

Explanations:

Please refer to T#0.

### 4.7 Word Devices & Bit Devices for Counters (C)

C#	Attribute	Register/coil name	Explanation	Default	Latched
0	R/W	Counter 0	Counting up/down counter	0/OFF	NO
1	R/W	Counter 1	Counting up/down counter	0/OFF	NO
2	R/W	Counter 2	Counting up/down counter	0/OFF	NO
3	R/W	Counter 3	Counting up/down counter	0/OFF	NO
4	R/W	Counter 4	Counting up/down counter	0/OFF	NO
5	R/W	Counter 5	Counting up/down counter	0/OFF	NO
6	R/W	Counter 6	Counting up/down counter	0/OFF	NO
7	R/W	Counter 7	Counting up/down counter	0/OFF	NO
8	R/W	Counter 8	Counting up/down counter	0/OFF	NO
9	R/W	Counter 9	Counting up/down counter	0/OFF	NO
10	R/W	Counter 10	Counting up/down counter	0/OFF	NO
11	R/W	Counter 11	Counting up/down counter	0/OFF	NO
12	R/W	Counter 12	Counting up/down counter	0/OFF	NO
13	R/W	Counter 13	Counting up/down counter	0/OFF	NO
14	R/W	Counter 14	Counting up/down counter	0/OFF	NO
15	R/W	Counter 15	Counting up/down counter	0/OFF	NO

Symbol "R" refers to ready only; "R/W" refers to read and write.

## C#0: Counter 0

Explanations:

When the counter is enabled and RX turns from OFF to ON, counting up or counting down will be set according to the settings. When the counting reaches the target, the counting will stop, and the bit device C0 will be set to ON. When the bit device is reset, the word device will be reset to 0 as well.

## C#1 ~ #15: Counter 1 ~ 15

Explanations:

Please refer to C#0.

### 4.8 Bit Devices for Real-Time Clock (R)

R#	Attribute	Content	Explanation	Default	Latched
0	R/W	RTC 0	Real-time clock	OFF	NO
1	R/W	RTC 1	Real-time clock	OFF	NO
2	R/W	RTC 2	Real-time clock	OFF	NO
3	R/W	RTC 3	Real-time clock	OFF	NO
4	R/W	RTC 4	Real-time clock	OFF	NO
5	R/W	RTC 5	Real-time clock	OFF	NO



R#	Attribute	Content	Explanation	Default	Latched
6	R/W	RTC 6	Real-time clock	OFF	NO
7	R/W	RTC 7	Real-time clock	OFF	NO
8	R/W	RTC 8	Real-time clock	OFF	NO
9	R/W	RTC 9	Real-time clock	OFF	NO
10	R/W	RTC 10	Real-time clock	OFF	NO
11	R/W	RTC 11	Real-time clock	OFF	NO
12	R/W	RTC 12	Real-time clock	OFF	NO
13	R/W	RTC 13	Real-time clock	OFF	NO
14	R/W	RTC 14	Real-time clock	OFF	NO
15	R/W	RTC 15	Real-time clock	OFF	NO

Symbol "R" refers to ready only; "R/W" refers to read and write.

**R#0: RTC 0**

Explanations:

When the RTC function is enabled, and the assigned trigger condition is true, RTU-EN01 will set the bit device R0 to ON and continue to output or stop according to the set time.

**R#1 ~ #15: RTC 1 ~ 15**

Explanations:

Please refer to R#0.

## 5 Modbus Communication

### 5.1 Function Codes Supported

Function code	Explanation	Devices supported
0x02	Read digital input point	RX, RY, T, R, C
0x03	Read register	BR, T, C, RCR
0x05	Write single bit device	RY, T, R, C
0x06	Write single register	BR, T, C, RCR
0x0F	Write multiple bit devices	RY, T, R, C
0x10	Write multiple registers	BR, T, C, RCR
0x17	Read/write multiple registers	BR, T, C, RCR

### 5.2 Exception Codes Supported

Exception code	Explanation
0x01	Illegal function
0x02	Illegal data address
0x03	Illegal data value
0x04	Slave device failure
0x0b	Gateway target device failed to respond.

## 5.3 Device Type & Device Address

Discrete input			
Device type	Modbus address (Hex)	6-digit Modbus address (Dec)	Number
RX	0x0400 ~ 0x04FF	101025 ~ 101280	256
Coil			
RY	0x0500 ~ 0x05FF	001281 ~ 001537	256
T	0x1600 ~ 0x160F	005633 ~ 005649	16
R	0x1900 ~ 0x190F	006401 ~ 006416	16
C	0x1E00 ~ 0x1E0F	007681 ~ 007696	16
Holding register			
Device type	Modbus address (Hex)	6-digit Modbus address (Dec)	Number
BR	0x0000~0x0040	400001~400064	64
T	0x1600~0x160F	405633~405649	16
C	0x1E00~0x1E0F	407681~407696	16
RCR	0x3000~0x3190	412289~412689	400

## 6 Setting up Software

This section gives instructions on how to set up RTU-EN01 by DCISoft and explanations on each setup page. RTU-EN01 is set up by UDP port 20006; therefore, you have to be aware of the relevant settings of the firewall. See the explanations below on the software.

### 6.1 Setting up Communications & Searching for Communication Modules in DCISoft

#### ■ Broadcast search

1. Open DCISoft on the PC and click on the "IP Search" icon.

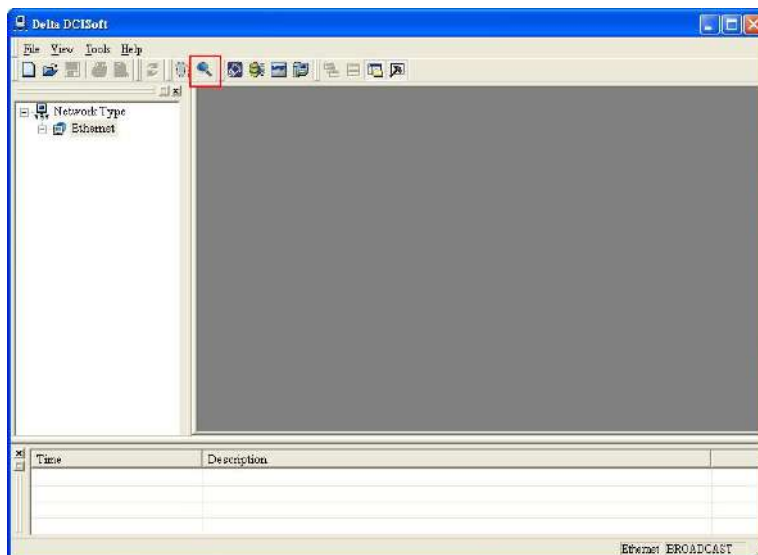

2. You will see the communication module found.

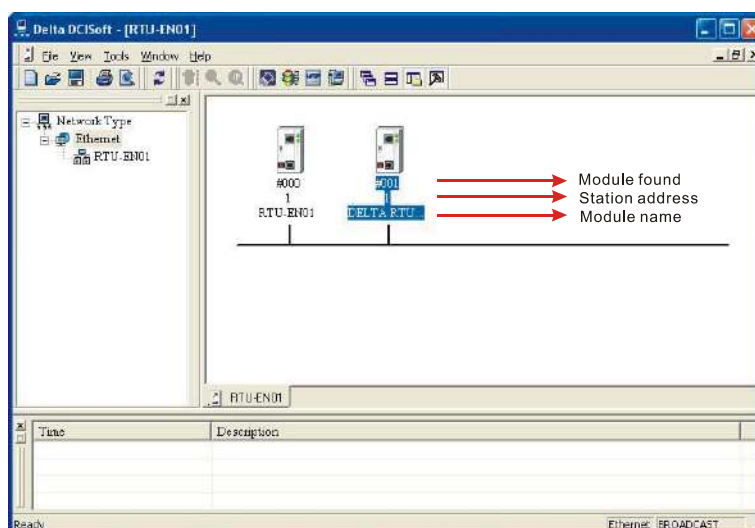
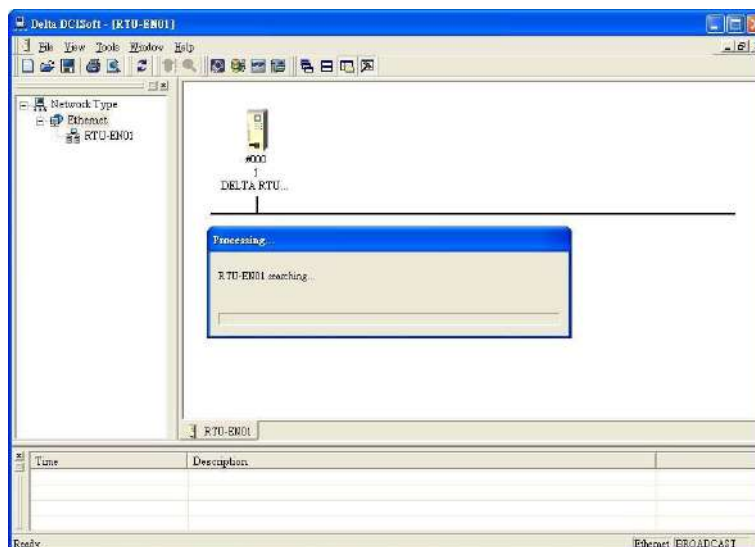

3. Double-click on the module to be set up to enter the setup page. The first page overviews the basic status of the module and information on the right-side module.

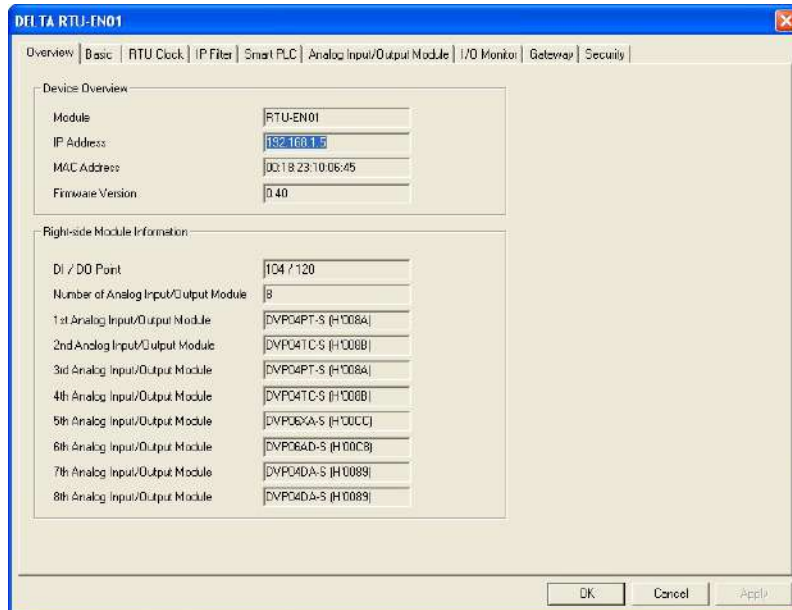

4. The next page is for basic network setup. Consult your Internet Service Provider for relevant network setting. For other settings, see BR#11 ~ BR#13.

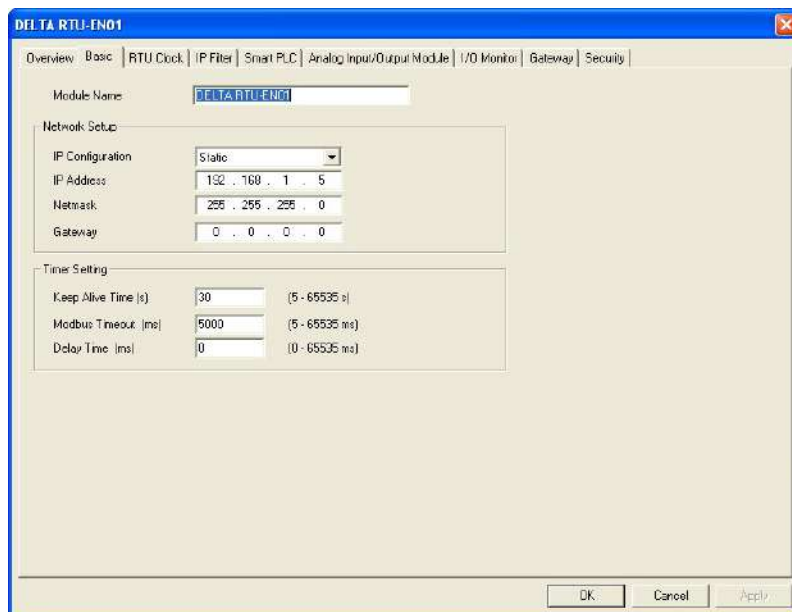

## 6.2 Recording IP Address

The IP list allows the user to select modules directly and designate a module for search. Recording IP address means to add this RTU-EN01 to the list, allowing the user to see RTU-EN01 in the search.

- Recording IP address

IP list:

In the list, you will see the network IPs already used. Click “Add” to record the known IP address into the list and next search for the module on the network by designated IP.

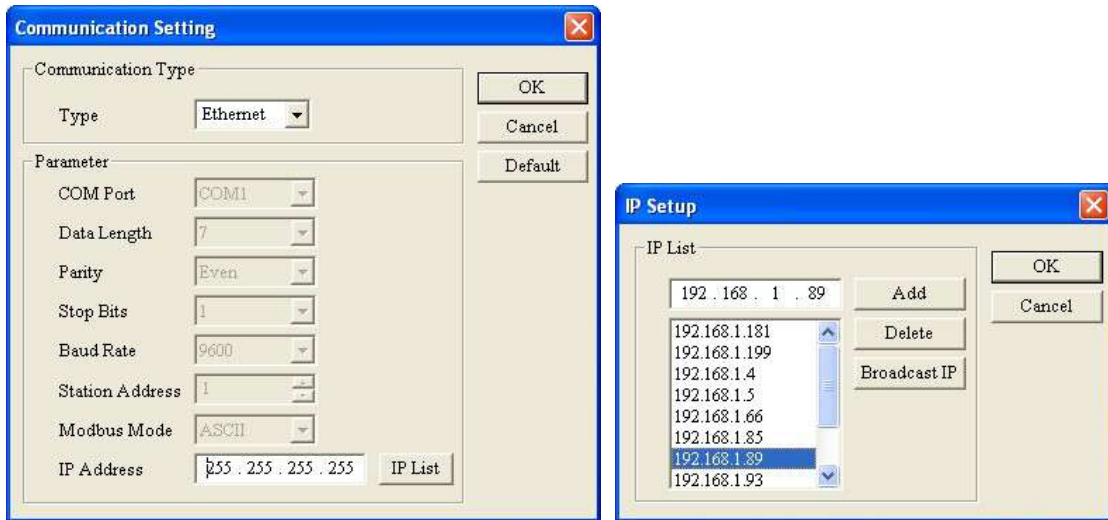

Click the icon to search for the module.

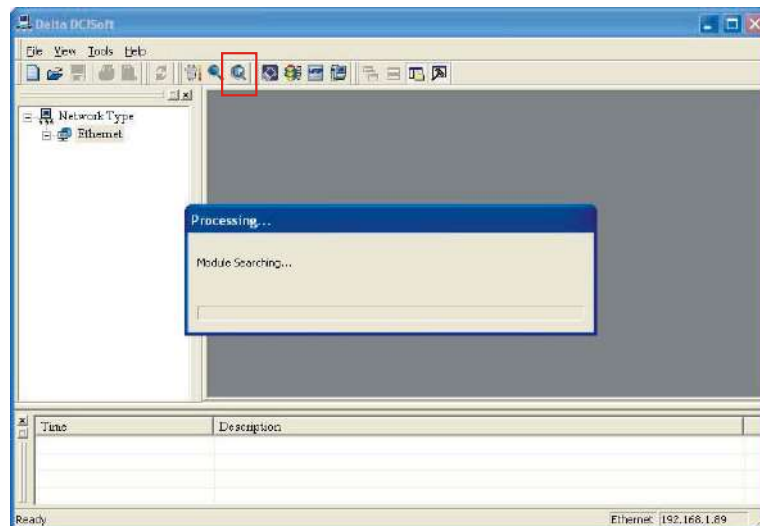

## 6.3 Basic Settings

The basic settings include parameters such as module name, network settings and communication time.

- The basics

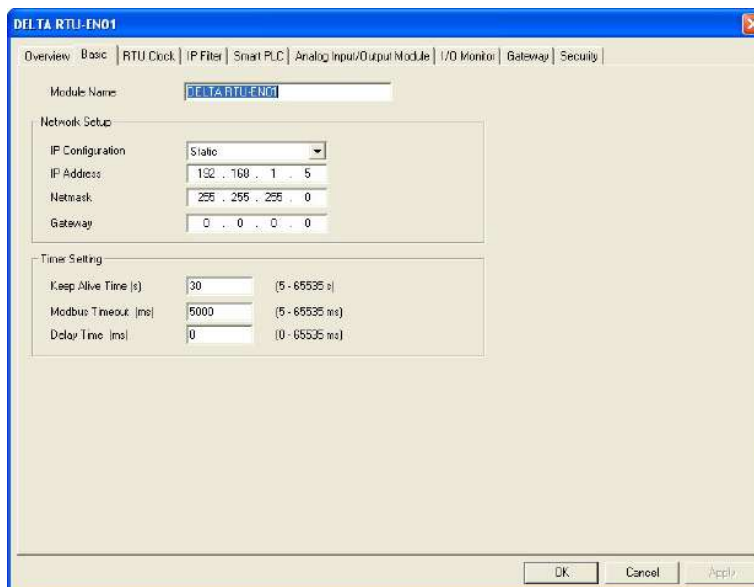

1. Module name:

There can be many RTU-EN01 modules on the network. Thus, you can set up a module name for each module to identify the module when you need to use them.

2. Network setup:

Enable dynamic IP (DHCP) or static IP. Consult your ISP for other relevant settings.

A. IP configuration:

There are 2 types of IP, static IP and DHCP.

Static IP: Preset or manually modified by the user.

DHCP: Automatically updated by the server. There must be a server in the LAN.

IP	Explanation
Static	The user enters the IP address, subnet mask and gateway.
DHCP	DHCP server offers the IP address, subnet mask and gateway.

B. IP address:

IP address is the location of the equipment on the network. Every equipment connected to the network has to have an IP address. Incorrect IP address will result in connection failure. Consult your ISP for how to set up IP address. The default IP for RTU-EN01 is 192.168.1.5.

C. Netmask:

Subnet mask is an important parameter for setting up the subnet, used for seeing if the destination IP and the local equipment are in the same subnet. If not, the equipment will send the packet to the gateway, and the gateway will send the packet to another subnet. Incorrect setting may cause the destination equipment unable to communicate to RTU-EN01. To see if your setting is correct, conduct bitwise AND operations between your IP and subnet mask and destination IP and subnet mask. If the two values obtained are the same, the two IPs are in the same subnet. The default subnet mask of RTU-EN01 is 255.255.255.0.

D. Gateway:

Gateway is the window for two different subnets, allowing the two ends in different subnets to communicate. For example, if the LAN has to be connected to WAN, it will need a gateway to bridge

the communication. The IP of the gateway has to be in the same subnet as RTU-EN01. The default gateway of RTU-EN01 is 192.168.1.1.

3. Timer setting:

For setting up TCP connection idle time, Modbus time-out and minimum delay time for every communication data. Please refer to the explanations on BR#11, BR#12, and BR#13.

## 6.4 Network Settings

The first step for all the equipment to connect to the network is to have its own IP (Internet Protocol) address. The IP address is like a number for every equipment to be identified on the network.

■ Setting up static IP of the PC

1. Enter Control Panel → Network Connection → click “Local Area Connection”.

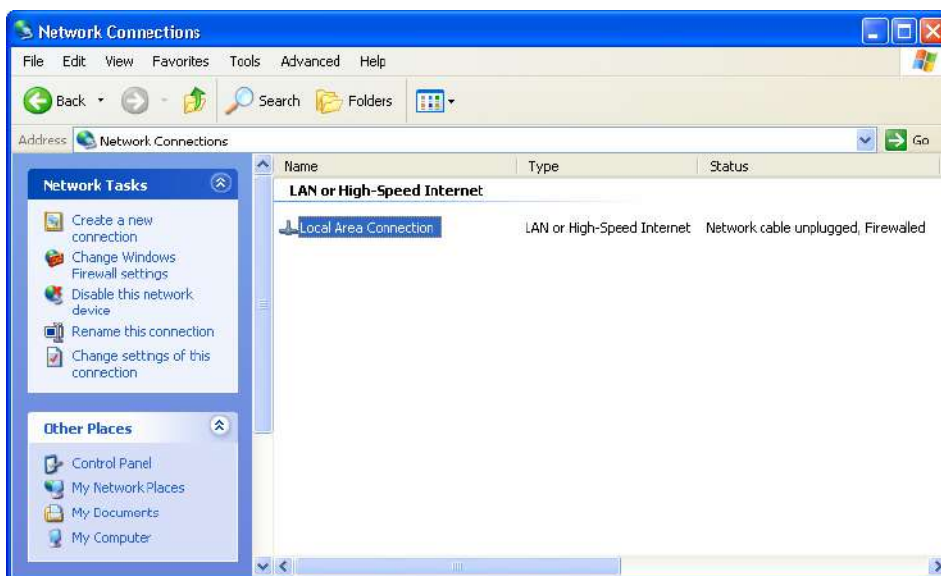

2. You will see the “Local Area Connection Status” window. Click “Properties”.

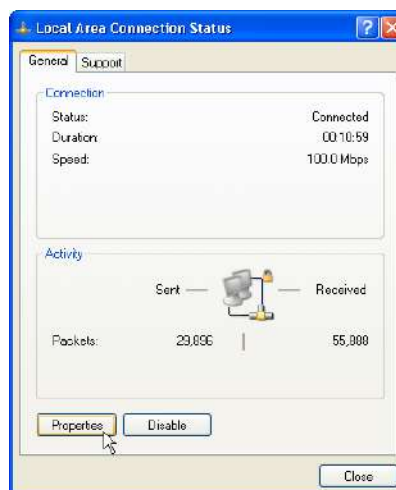

3. Click “Internet Protocol (TCP/IP)”.

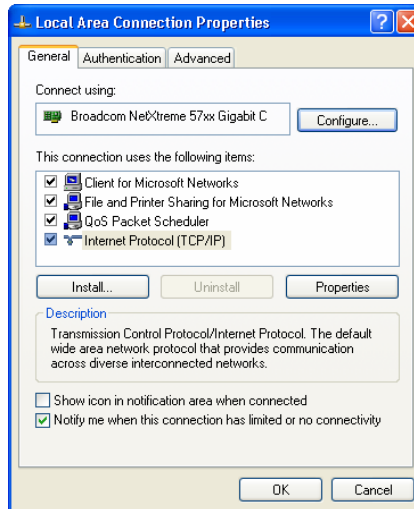

4. Enter "192.168.0.2" into IP address. Click "OK" to complete the IP address setting of the PC.

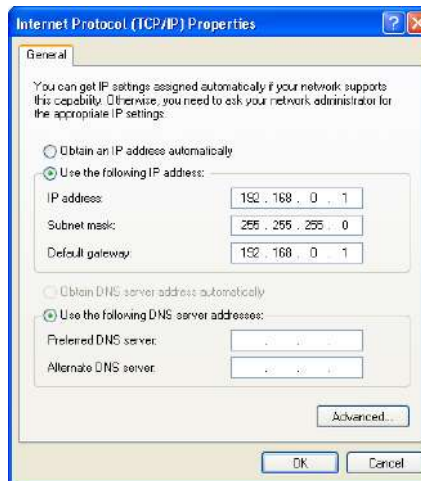

## 6.5 Setting up Time Server

RTU-EN01 offers real-time clock (RTC) functions. You can set up your own time for RTU-EN01 or update the time through NTP server.

- Setup page

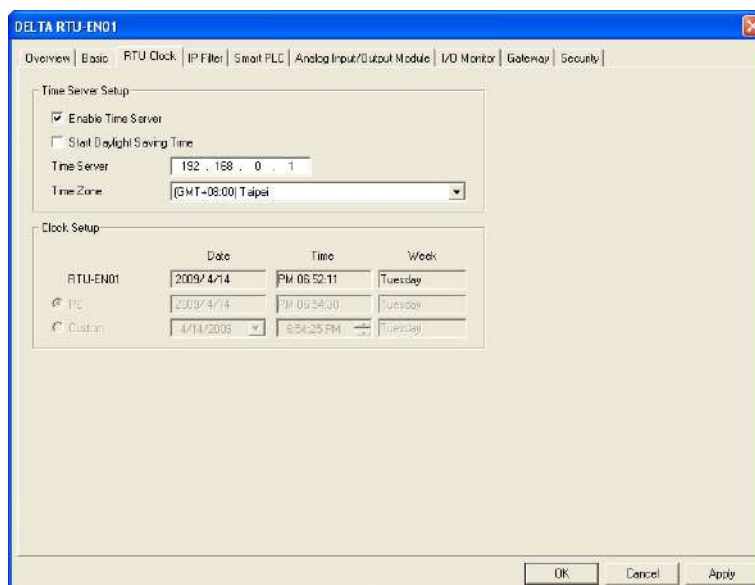



1. Enable time server:  
RTU-EN01 execute automatic time correction from the NTP server on the network every 6 hours to ensure the time is correct in the RTC. To enable this function, you have to set up first the IP address of the NTP server and the time zone and daylight saving time which your RTU-EN01 is in.
2. Start daylight saving time  
Daylight Saving Time; also known as summer time, is a conventional local time adopted by many countries in the world on a seasonal basis. Most commonly DST is obtained by adjusting the official local time forward, by one hour, for the spring, summer, and early autumn periods.
3. Time server:  
IP address of the time server. You can acquire correct time from the time server to correct the time in the MPU.
4. Time zone:  
There are 24 time zones on earth and follow Greenwich Mean Time (GMT) as the standard time. Select the time zone you are in and adjust the offset between the time of your city and Coordinated Universal Time (UTC).
5. Clock setup:  
Set up the time in RTU-EN01. You can set the time to the same as the PC in operation, or you may as well set up the time manually.

## 6.6 IP Filter

The IP filter is used for restricting the connection of the network in case some uncertain UP will cause errors. Only the IP set within a certain range can establish a connection. Other IPs will be rejected.

### ■ Setting up IP filter

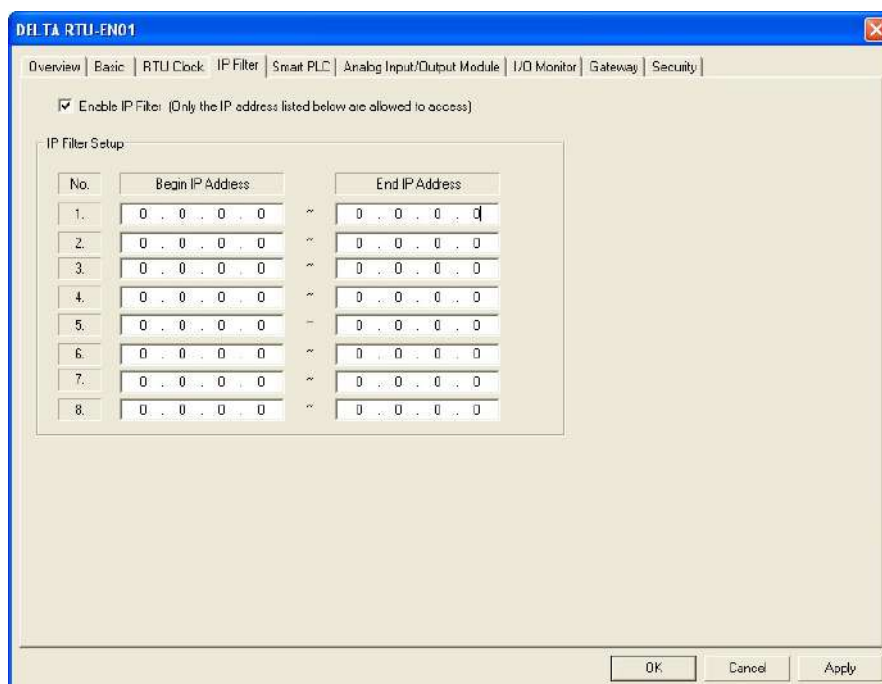

1. Enable IP filter:

Check the box to enable IP filter.

2. Begin IP address:  
Start IP addresses allowed to establish connection. Max. 8 IPs are allowed.
3. End IP address:  
End IP addresses allowed to establish connection. Max. 8 IPs are allowed.

## 6.7 Smart PLC Setting: IF-THEN

RTU-EN01 has the independent Smart PLC function. IF-THEN is able to execute the corresponding function of the condition set up by the user and combine with the functions of counter, timer, RTC, digital I/O points and analog I/O modules. You can use AND or OR as the trigger condition. There are 16 IF-THEN functions in RTU-EN01.

### ■ IF-THEN

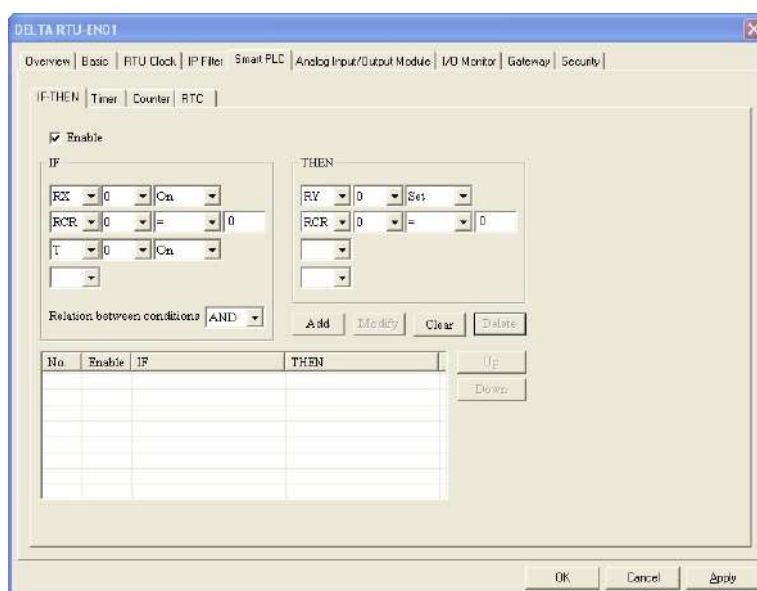

1. Enable:  
Check the box to enable IF-THEN.
2. IF:  
For the trigger condition, you can select bit devices RX, RY, C, T, RT or word device RCR and set them to ON, OFF, Rising, Falling, >, <, =, <>, >= or <=. The trigger condition can be AND or OR. When the device is a register, the allowed trigger range will be K-32,768 ~ K32,767.
3. THEN:  
For the execution, you can select bit devices RY, C, T, RT or word device RCR and set them to Set, Reset, Toggle or set up a value for them. Please refer to the explanations on IF#13 ~ IF#24. When the device is a register, the allowed trigger range will be K-32,768 ~ K32,767.
4. Add, Modify, Clear, Delete:  
All the settings above can be added to the IF-THEN table below, or you can modify, clear or delete the settings.
5. Up, Down:

You can move the IF-THEN setting upwards or downwards to change the execution order of them.

## 6.8 Smart PLC Setting: Timer

RTU-EN01 has the independent Smart PLC function. The timer is able to time following the system time. There are 16 timers in RTU-EN01. The timing range is 10ms ~ 655,35s.

### ■ Timer

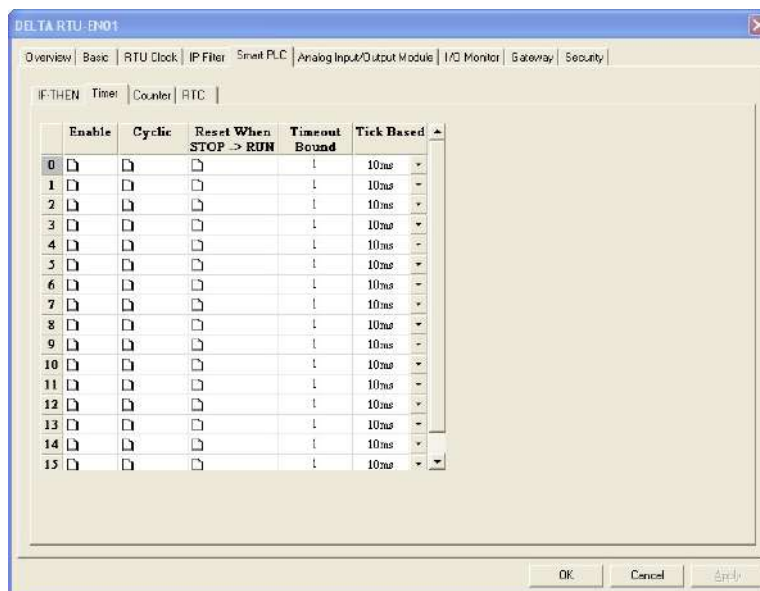

1. Enable:  
Decide whether to enable the timer in this column.
2. Cyclic:  
Decide whether to reset the timer and re-start the timing when the timing reaches the target in this column.
3. Reset when STOP->RUN:  
Decide whether to reset the timer when the system goes from STOP to RUN.
4. Timeout bound:  
The time for the timer to reach the target. Range: 10ms ~ 65,535s.

## 6.9 Smart PLC Setting – Counter

RTU-EN01 has the independent Smart PLC function. The counter can be triggered by the external input points RX. When RX turns from OFF to ON, the counter will start to count. There are 16 counters in RTU-EN01, responsible for counting up and counting down. The counting range is -32,768 ~ 32,767.

### ■ Counter

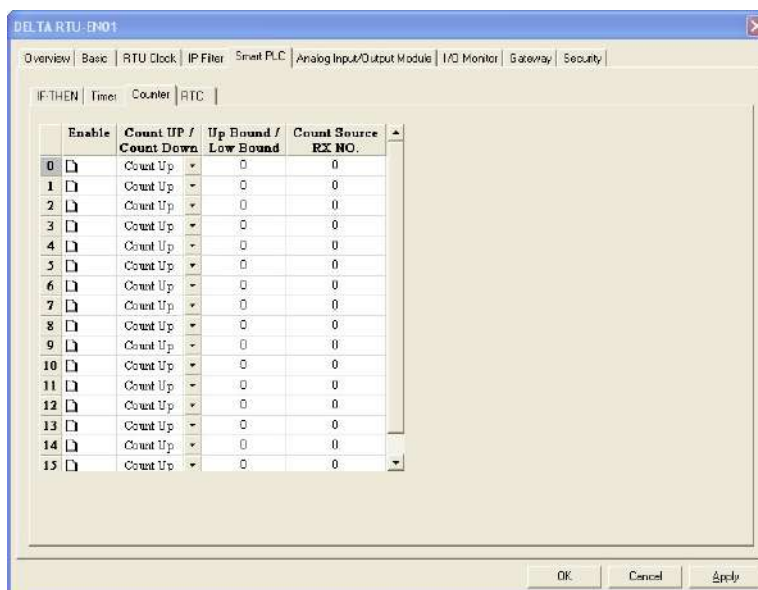

1. Enable:  
Decide whether to enable the counter in this column.
2. Count up/count down:  
Decide whether the counter will be counting up or counting down.
3. Up bound/low bound:  
The upper bound and lower bound of the counting. Range: -32,768 ~ 32,767.
4. Count source RX NO.:  
No. of the external input point RX of the counting source. Range: RX#0 ~ RX#255.

## 6.10 Smart PLC Setting – RTC

RTU-EN01 has the independent Smart PLC function. The real-time clock (RTC) can be triggered by the system at specific time. There are 16 RTCs in RTU-EN01. You can designate the trigger time or trigger the RTC on a monthly, weekly or daily basis. Please refer to the explanations on RS#0 ~ RS#159.

### ■ RTC

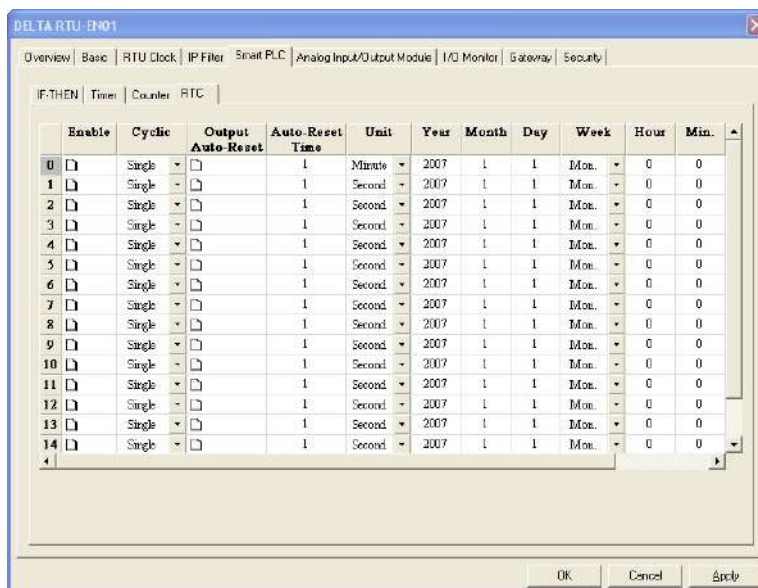

1. Enable:  
Decide whether to trigger the RTC in this column.
2. Cyclic:  
Decide to trigger the RTC only once, or trigger it on a daily, weekly or monthly basis.
3. Output auto-reset:  
After the RTC is triggered, decide whether to retain the output for a period of time and reset the RTC automatically. R (Coil) will be OFF when the time for reset is reached.
4. Auto-reset time, Unit:  
If you select to auto-reset the RTC, the bit device in RTC will retain the output for a period of time.  
Range: 1s ~ 24hr.  
Range for second as unit: 1 ~ 32,767  
Range for minute as unit: 1 ~ 3,600  
Range for hour as unit: 1 ~ 24
5. Year, Month, Day, Hour, Minute, Second, Week:  
The time to trigger the RTC. If you would like to trigger it only once, only Year, Month, Day, Hour, Minute and Second need to be set. If you would like to trigger on a daily basis, only Hour, Minute and Second need to be set. If you would like the RTC to be triggered on a weekly basis, you only need to set up Week, Hour, Minute and Second. If the RTC is triggered monthly, set up only Day, Hour, Minute and Second.

## 6.11 Analog Input/Output Modules

RTU-EN01 offers control registers (CR) for analog I/O modules and is built-in with mapping tables of CR for read/write. The user can check the CR to be read/written and use Delta's communication module DVPEN01-SL to map the CR directly to D registers in DVP-SV series PLC and read/write the D register through PLC program, controlling the analog I/O module connected to RTU-EN01. RTU-EN01 supports maximum 64 data reading/writing.

► This function works with DVPEN01-SL of firmware V2.0 or versions above.

■ Analog I/O modules

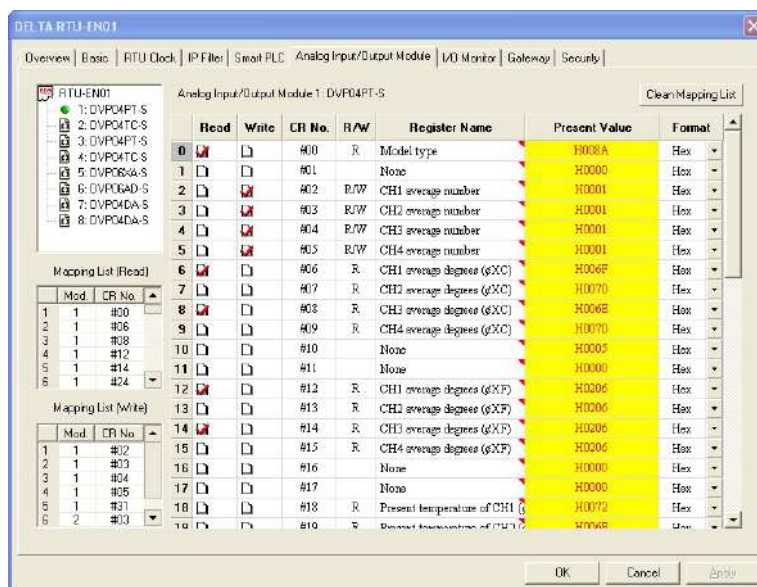

- Corresponding table:**

Open DCISoft and it will automatically load in the control register information on the analog I/O modules. (When using Web settings, you have to load in the EDS file for analog I/O module by yourself.) Check the CR you are to read or write to establish a mapping table. DVPEN01-SL will map the CR established in the table to D register in DVP-SV series PLC. The user will be able to operate the analog I/O module connected to RTU-EN01 by the value stored in D register.
- Read:**

Check the CR (read) to be added to the mapping table. Click “Apply” and the checked CR will be added.
- Write:**

Check the CR (write) to be added to the mapping table. Click “Apply” and the checked CR will be added.
- Clean mapping list:**

Once applied, clear all the information in the mapping table.
- CR No.:**

The number of control register for all analog I/O modules connected to RTU-EN01.
- R/W:**

Indicating whether the CR can be read or written.
- Register name:**

The name of the CR for the analog I/O modules.
- Present value:**

The present value in the CR for the analog I/O modules.
- Format:**

The display format for the present value in the CR. Available formats: hex, signed decimal integer and binary integer.

## 6.12 I/O Monitoring Table

RTU-EN01 is able to monitor internal registers on-line. Scroll the table to monitor bit devices RX, RY, T, C, R, RCR and BR and the bit status and present value in the register. You can choose to monitor decimal or hex present value.

- I/O monitoring table:

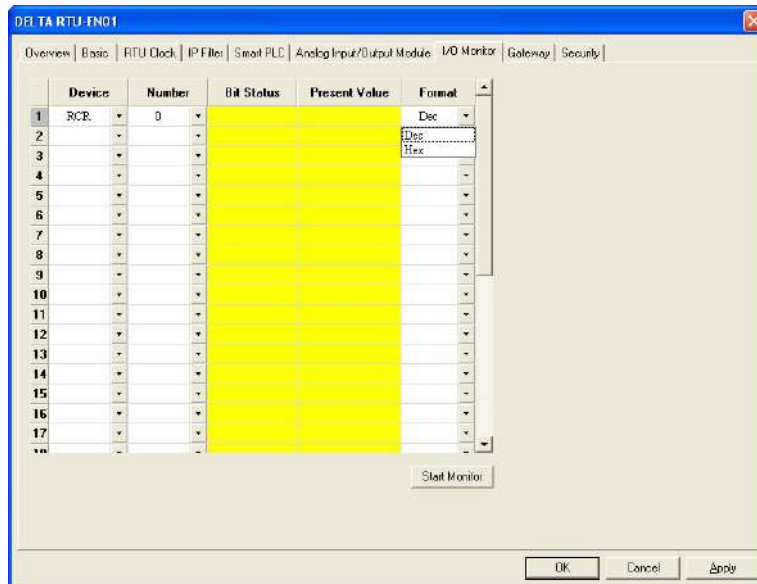
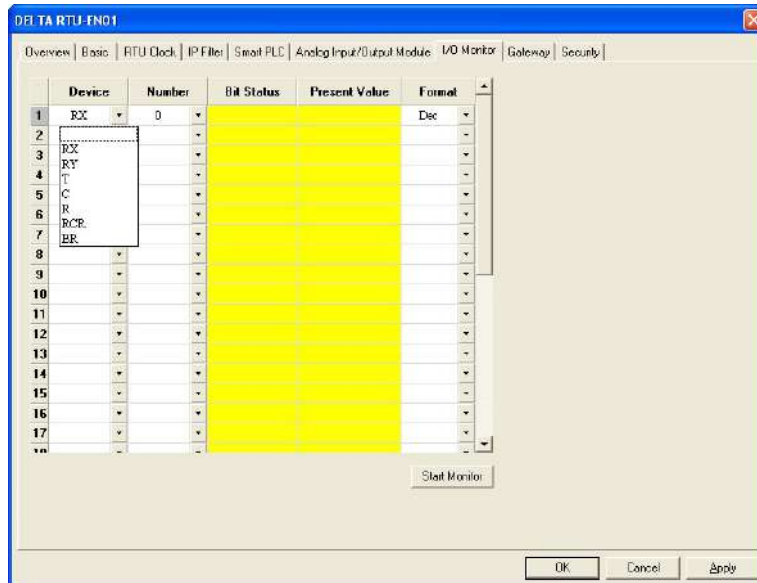

1. Device:
  - Select an internal register in RTU-EN01.
  - Bit devices: RX, RY, T, C, R
  - Registers: T, C, R, RCR, BR.
2. Number:
  - Select the bit devices and registers to be monitored by their numbers.
  - RX#0 ~ RX#255, total 256 bits.
  - RY#0 ~ RY#255, total 256 bits.

T#0 ~ T#15, total 16 bits and 16 registers.

C#0 ~ C#15, total 16 bits and 16 registers.

R#0 ~ R#15, total 16 bits and 16 registers.

RCR#0 ~ RCR#399, total 400 registers.

BR#0 ~ BR#63, total 64 registers.

### 3. Format:

Select the format of the register to be monitored, decimal (Dec) or hexadecimal (Hex).

- ▶ Once the number and format are set, click “Apply” to save the setting and start the monitoring.

### 4. Start/Stop monitor:

Start or stop the saved and applied device number to be monitored. Unapplied saved settings will be deleted.

## 6.13 Setting up Gateway

RTU-EN01 offers Modbus TCP to RS-485 gateway functions. By setting up RTU-EN01, you can read the data in specific devices on the network. Gateway functions help you fast store and retrieve data and offers on-line monitoring for maximum 100 bit data and word data. The data can be temporarily stored in RTU-EN01, speeding up the write/read and response time.

### ■ Gateway setup page

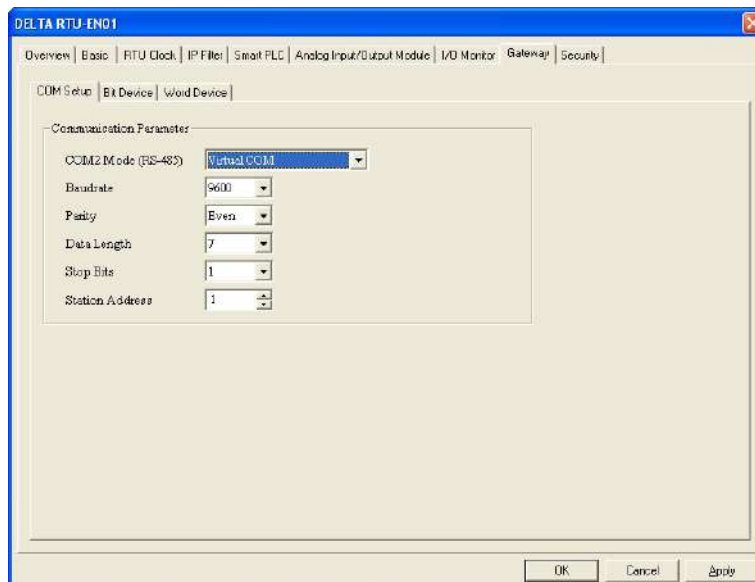

#### 1. COM Setup

##### ■ COM2 Mode (RS-485):

You can choose Modbus ASCII Master, Modbus RTU Master or Virtual COM.

##### ■ Baudrate:

The baud rate for communication.



- Parity
- Data length
- Stop bits
- Station address:

The Modbus address.

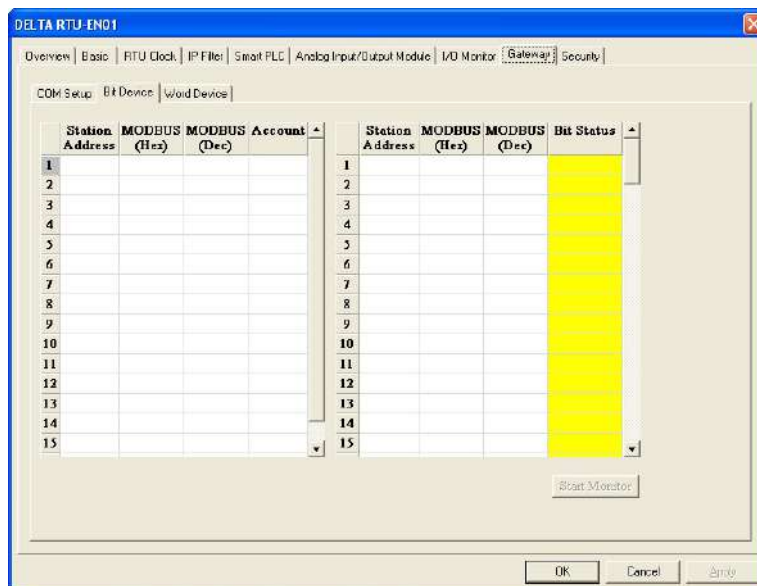

## 2. Bit device

For setting up the addresses for the bit type serial slave device and reading or the content in the designated slave.

- Station address:  
Enter the address of slave to be monitored. (Max. 16 slaves)
- MODBUS (Hex):  
Enter the 4-digit hex Modbus address of the slave to be monitored.
- MODBUS (Dec):  
Enter the 6-digit decimal Modbus address of the slave to be monitored.
- Account:  
Enter the number of slaves to be monitored continuously (Max. 100).

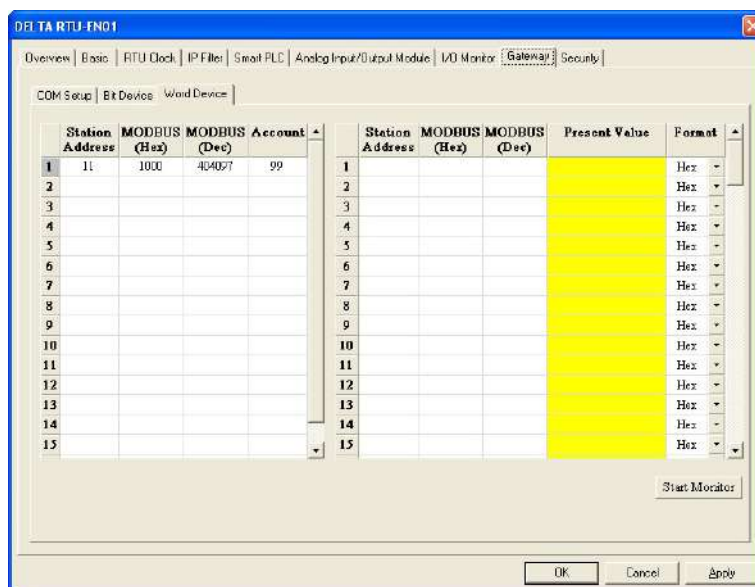

### 3. Word device

For setting up the addresses for the word type serial slave device and reading or the content in the designated slave.

- **Station address:**  
Enter the address of slave to be monitored. (Max. 16 slaves)
- **MODBUS (Hex):**  
Enter the 4-digit hex Modbus address of the slave to be monitored.
- **MODBUS (Dec):**  
Enter the 6-digit decimal Modbus address of the slave to be monitored.
- **Account:**  
Enter the number of slaves to be monitored continuously (Max. 100).
- ▶ Once the information of slave monitoring is set, click "Apply" to save the setting and start the monitoring. Incomplete device information will be deleted.
- **Format:**  
Select the format of the register to be monitored, decimal (Dec), hexadecimal (Hex) or binary.
- **Start/Stop monitor**  
Start or stop the saved and applied device number to be monitored. Unapplied saved settings will be deleted.

#### Note:

The default is in cache enabled mode. You can set up maximum 16 sets of slave information for the monitored bits and words (Max. 100 data). Under the cache mode, you are able to send the read data back to the registers in RTU-EN01.

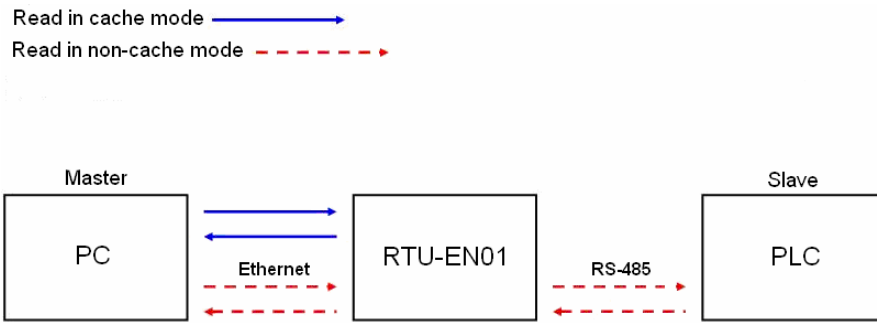

## 6.14 Virtual COM

The virtual COM converts the data sent to RS-232 port into Ethernet.

- Select Virtual COM for COM2 mode (RS-485).

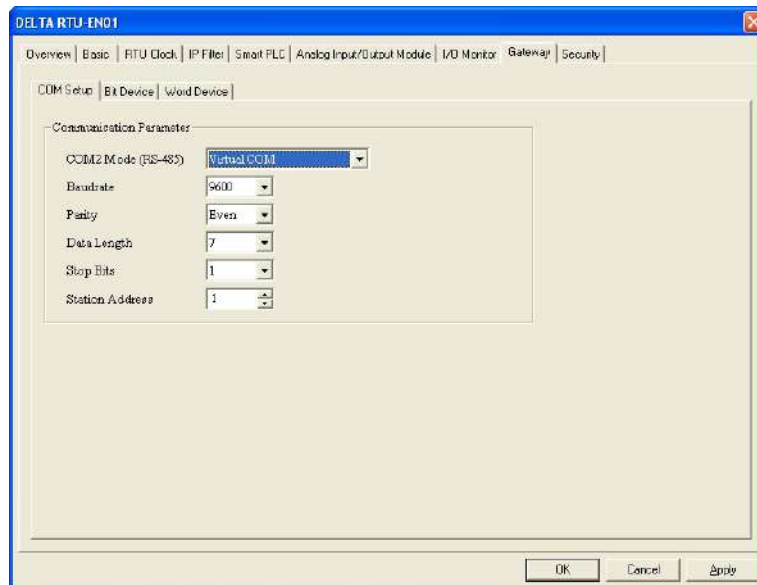

- The default setting for listen port is 20001.
- Open the setup page for Virtual COM.

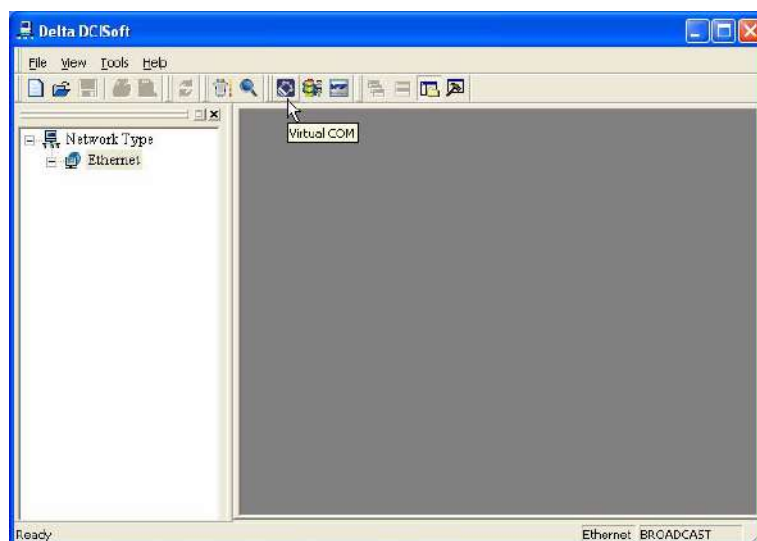

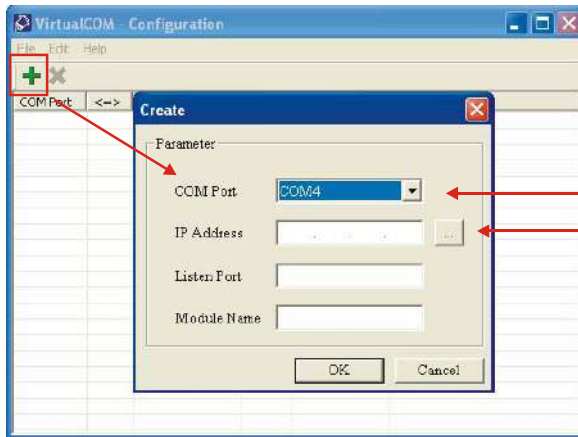

Select COM port  
Search device on network or  
enter IP address

- Press “Search”, and you will see all the connected devices on the network

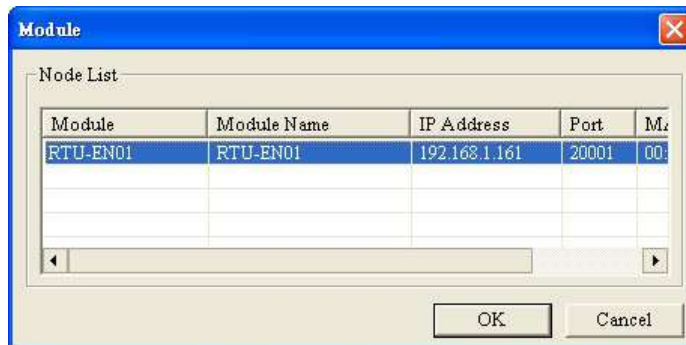

- Select the device and click “OK”. Information on the device will be loaded in automatically. Press “OK” to complete the setup.

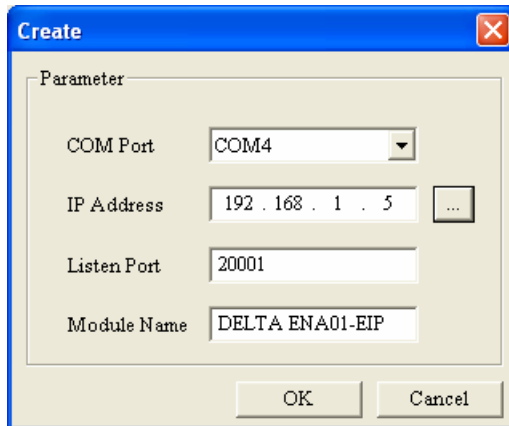

- Once the setup is completed, you will then be able to see the virtual COM just set in “Computer Management”.

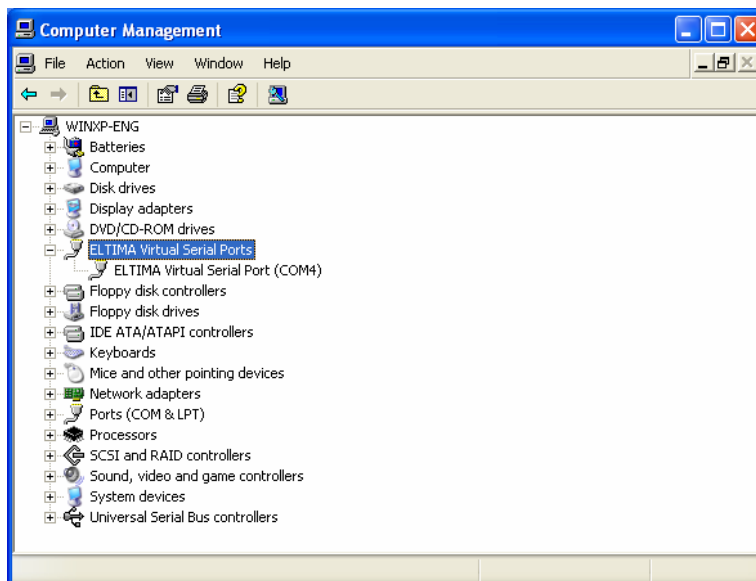

## 6.15 Security Setting

To prevent the set values in RTU-EN01 from being modified, you can set up passwords to lock the settings in RTU-EN01.

### ■ Setting up password

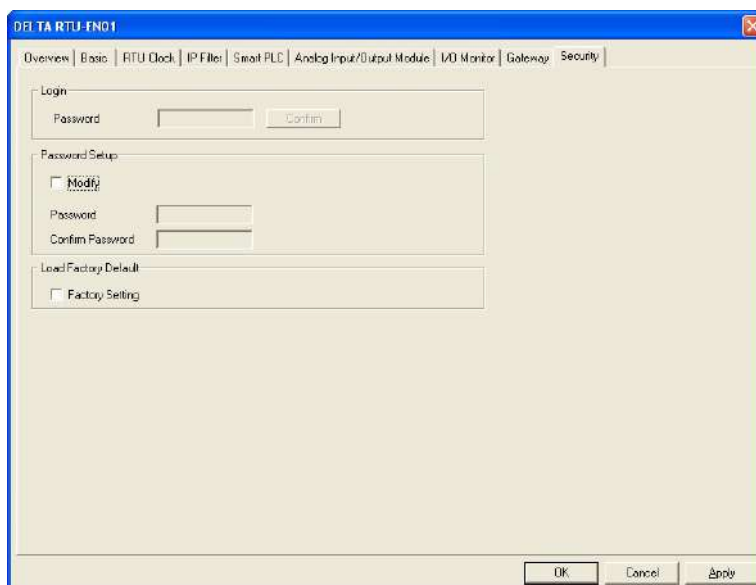

1. Login:  
Log in to check and modify parameters.
2. Password setup:  
Check the "Modify" box to set up the password.
3. Password:  
Enter maximum 4 characters. Leave it blank to clear the password.
4. Confirm password:  
Enter the new password again.

#### Note:

Once the password is locked, all the pages cannot be set up unless you unlock the password.

However, if you set up RTU-EN01 by RS-232, you can return the setting to default one whether the password is locked or not. For example, if you have locked RTU-EN01 but forget the password, you have to return RTU-EN01 to default setting by RS-232, and all the settings will return to default ones.

## 6.16 Returning to Default Settings

If you need to clear all the settings after many modifications have been done on the settings and return the settings to default ones, check the “Factory Setting” box.

- Returning to default settings

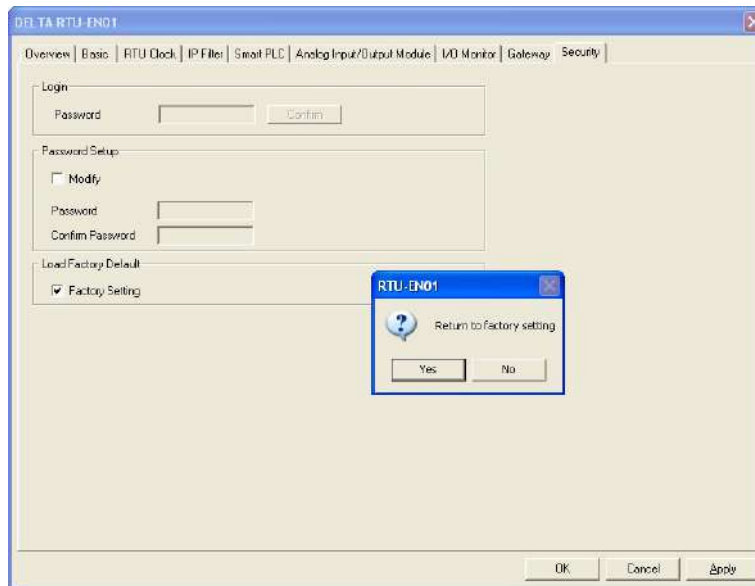

Check “Factory Setting” box and click on “Yes”.

Note:

If you set up RTU-EN01 by RS-232, you can return to settings to default ones whether the password is locked or not. It will take approximately 10 seconds to return to default settings, so DO NOT switch off the power within the 10 seconds.

## 6.17 Web Function

RTU-EN01 offers Web function for the user to connect through Internet browser (e.g. Internet Explorer). You can set up and monitor RTU-EN01 by this function.

1. See the connection method (as below) and 6.1 for how to set up communication.

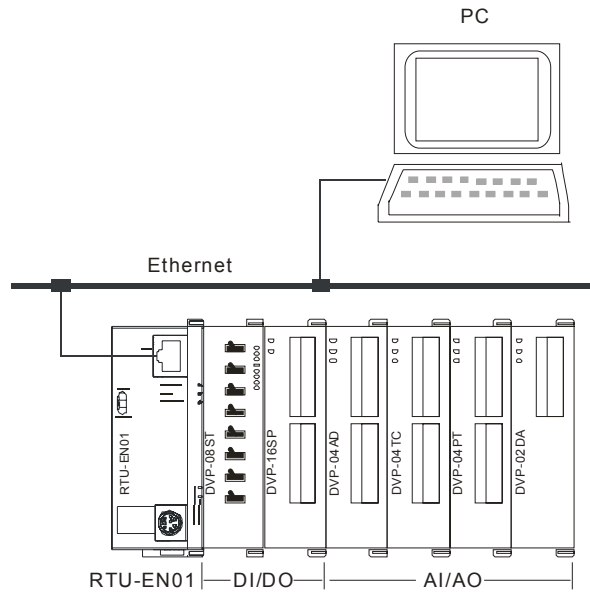

- Open Internet Explorer and enter IP address "192.168.1.5" (default) of RTU-EN01. You can also copy the IP address of RTU-EN01 in DCISoft and paste it to the address column on IE. Press "Enter" on keyboard to open the webpage.

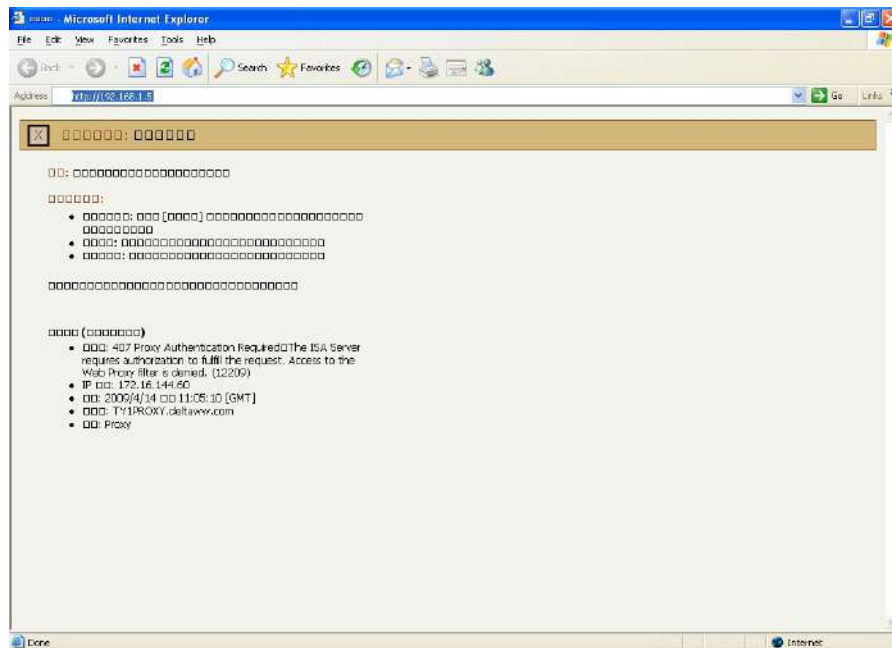

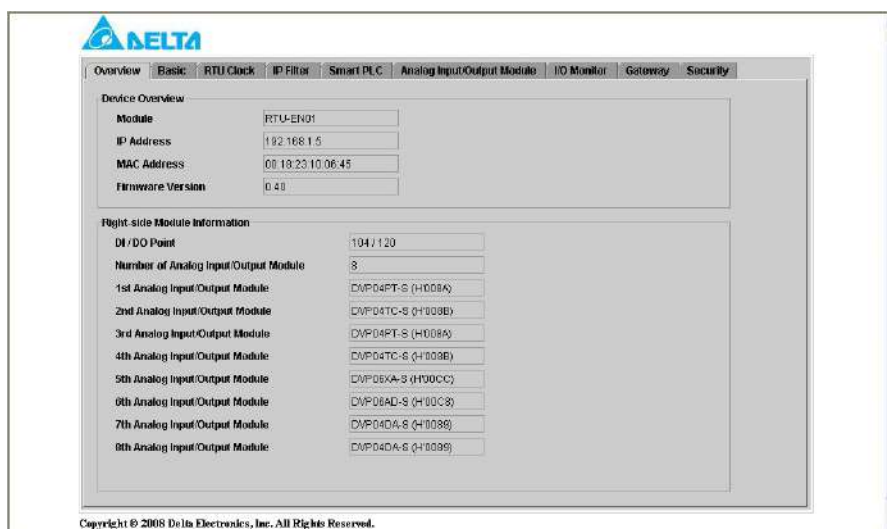
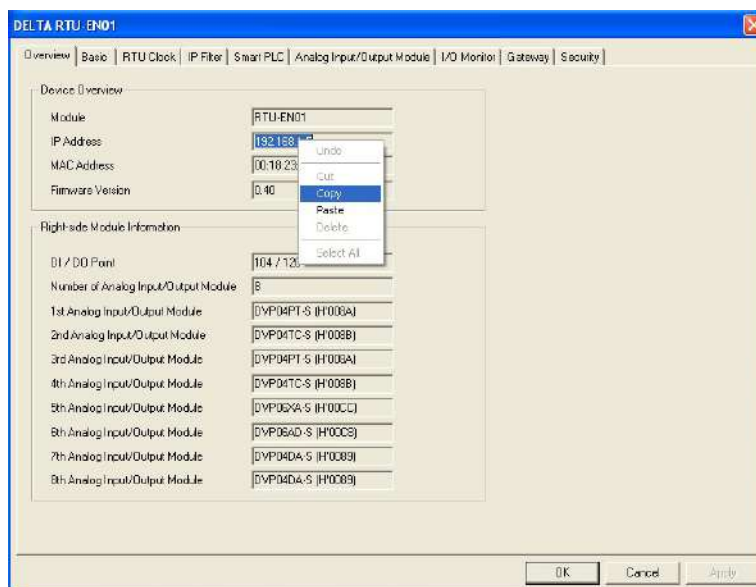

3. To use the page of analog input/output modules on the web, download "DeltaR-Side-S\_ENU.edc" file from Delta's website first and import the file to the page. Other settings are the same as the settings in DCISoft. The webpage supports Java Runtime Environment (JRE) v1.4.2\_xx and versions above.

#### 4. Webpage troubleshooting

Unable to connect:

- (1) Check if Java is correctly installed. Connect to the Java page to confirm.
- (2) Check Proxy settings. Close Proxy or set up exceptions.

Close Proxy:

1. In IE, select "Tool" => "Internet Options...".



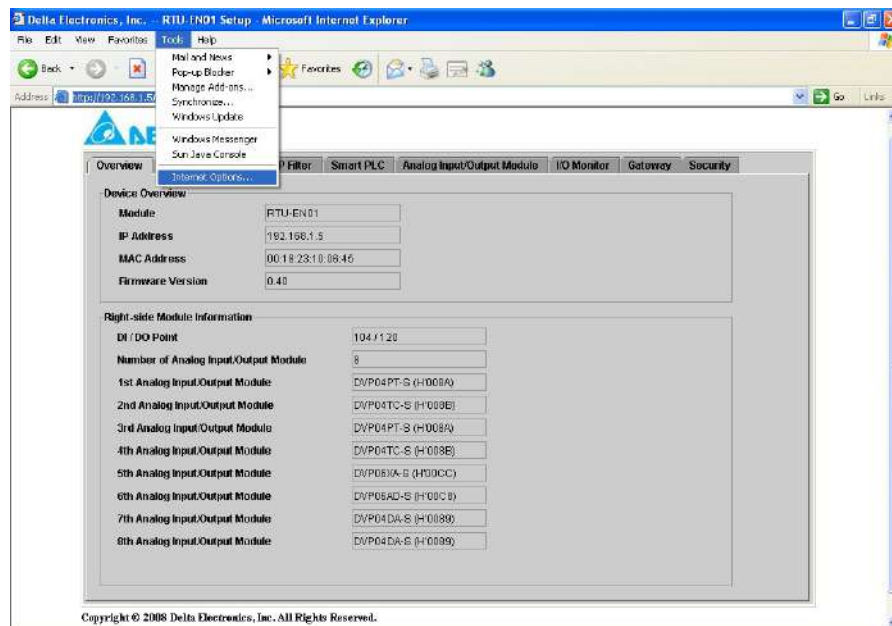

2. Select "Connections" and Click "LAN Settings...".



3. Uncheck "Proxy server" options and click "OK".

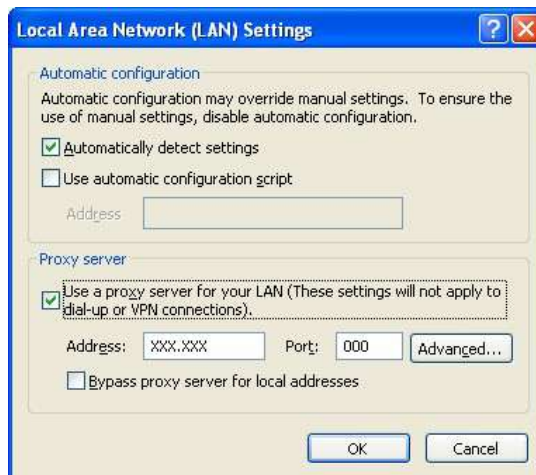

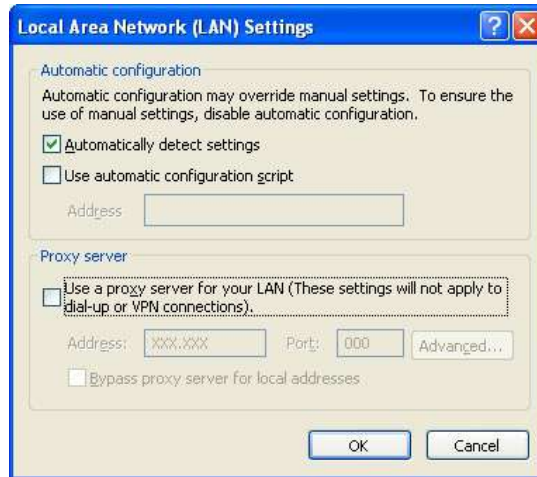

Set up exceptions:

1. Click "Advanced..." on Local Area Network (LAN) Settings page.

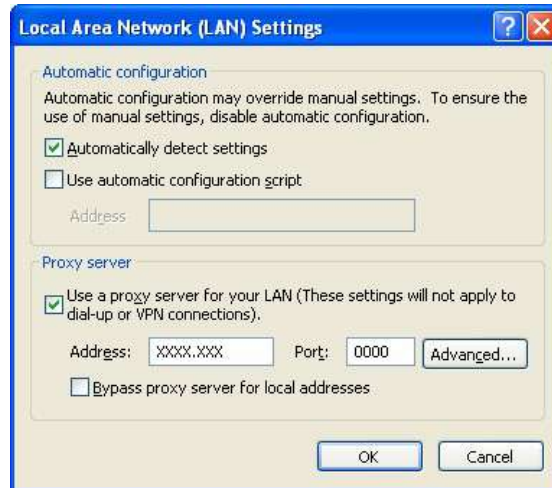

2. Enter the IP address "192.168.1.5" of RTU-EN01 in Exceptions.



3. Click "OK".

Abnormal webpage action: In this case, please clear your temporary Internet files.

Clear temporary Internet files:

1. In IE, select "Tool" => "Internet Options...".

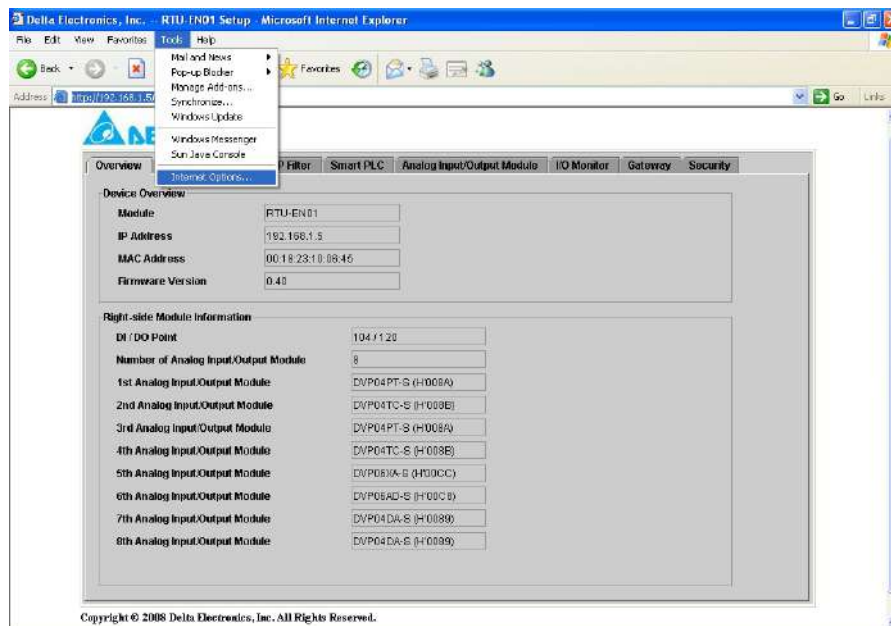

- In "General" page, click "Delete Files..." in Temporary Internet files column.



- Check "Delete all offline content" and click "OK" to start the deletion.



- Click "OK" to leave the "General" page.

## 7 Application Examples – DCISoft

### 7.15 Smart PLC: IF-THEN

Application	Setting up IF-THEN in Smart PLC functions by using DCISoft.
Steps	<ol style="list-style-type: none"> <li>When RX#0 and RX#1 are ON, set RY0 to output.</li> <li>When RX#2 turns from OFF to ON, set RY1 to reversing its direction.</li> </ol>

- See the connection method (as below) and 6.1 for how to set up communication.

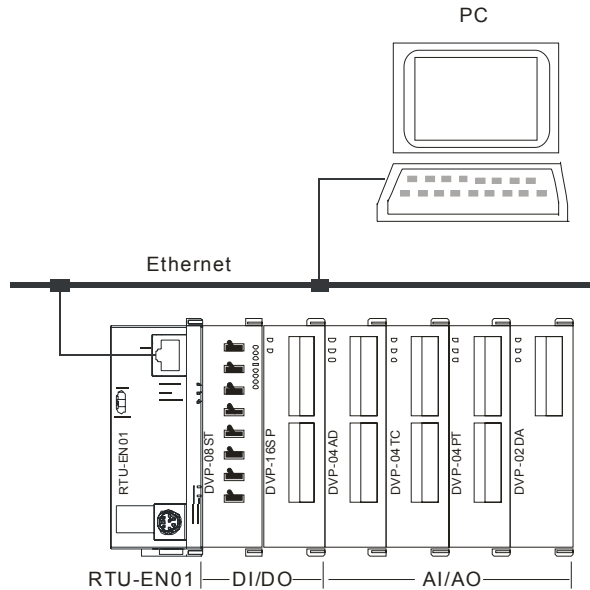

- Open the setup page and switch to “Smart PLC” page.
- Select “RX 0 On” and “RX 1 On” in the IF column and select “AND” for the relation between conditions. Next, select “RY 0 Set” in the THEN column and press “Add” to add the settings into the table below.

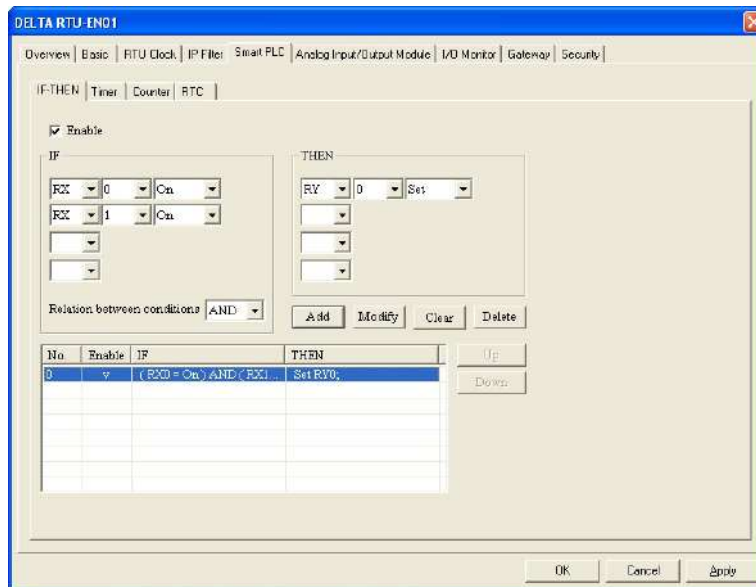

- Select “RX 2 Rising” in the IF column and “RY 1 Toggle” in the THEN column. Press “Add” to add the settings into the table below. Press “Apply” to store these settings into RTU-EN01.

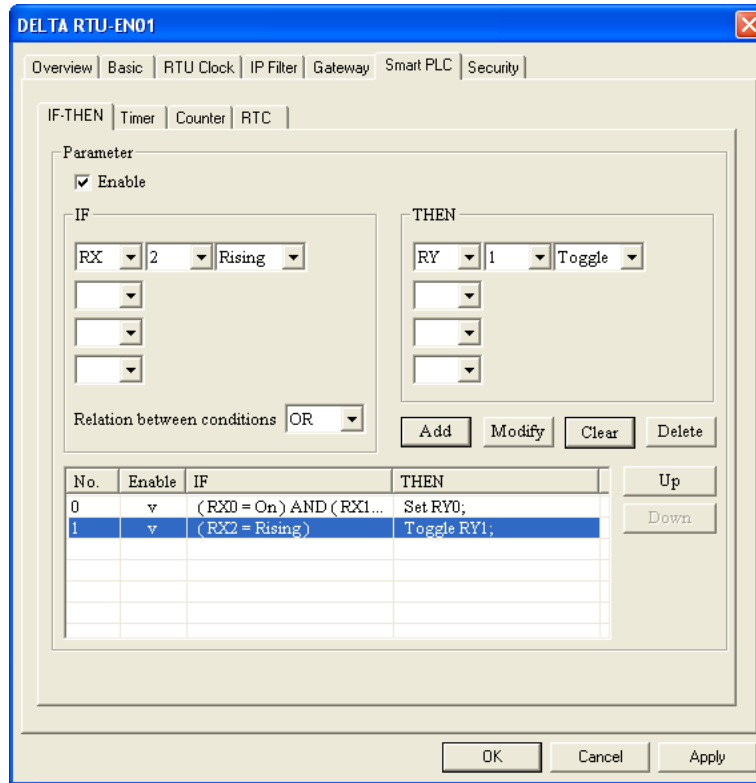

## 7.16 Smart PLC: Timer

Application	Setting up Smart PLC functions by DCISoft. After RY0 is On for 1 second, it will turn Off for 500 ms. This will repeat in cycle.
Steps	(1) Set up the timer: Timer 0 1s, Timer 1 500ms. (2) Set up IF-THEN: When the timing reaches the target, RY0 will be On or Off.

1. Open the setup page and switch to “Smart PLC” page. Further switch to the “Timer” page.
2. Check to “Enable” Timer 0 and Timer 1 and set Timer 0 to “1s” and Timer 1 to “500ms”. Click “Apply” to write the settings into RTU-EN01.

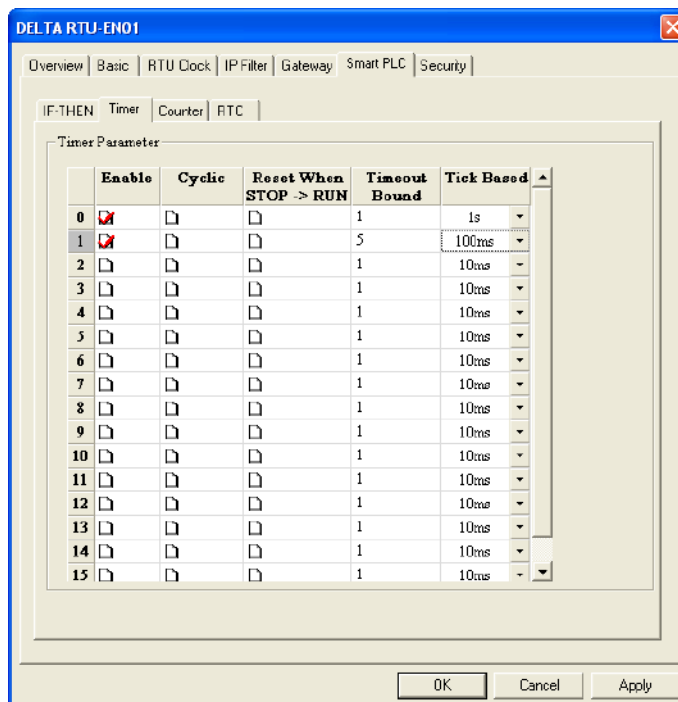

## 7.17 Smart PLC: Counter

Application	Setting up the counter by DCISoft. Once RX#1 counts for 5 times, RY0 will output.
Steps	(1) Set up counter C0: RX#1 counts up 5 times and reaches the target. (2) Set up IF-THEN: When the counting reaches the target, RY0 will output.

1. Open the setup page and switch to “Smart PLC” page. Further switch to the “Counter” page.
2. Check to “Enable” Counter 0, select “Count Up”, set Up Bound to “5” and Count Source RX NO. to RX”1”. Click "Apply" to write these settings into RTU-EN01.

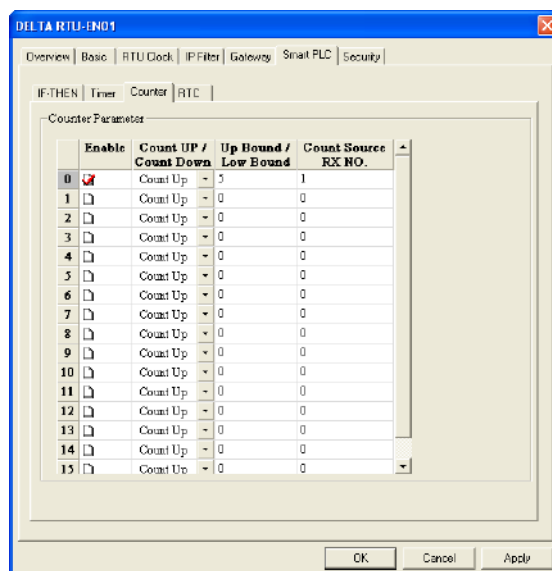

3. Switch to “IF-THEN” page and check the “Enable” box. Select “C 0 On” in the IF column and “RY 0 Set” in the THEN column. Click on “Add” to add the settings to the table below and press “OK” to save the settings into RTU-EN01.

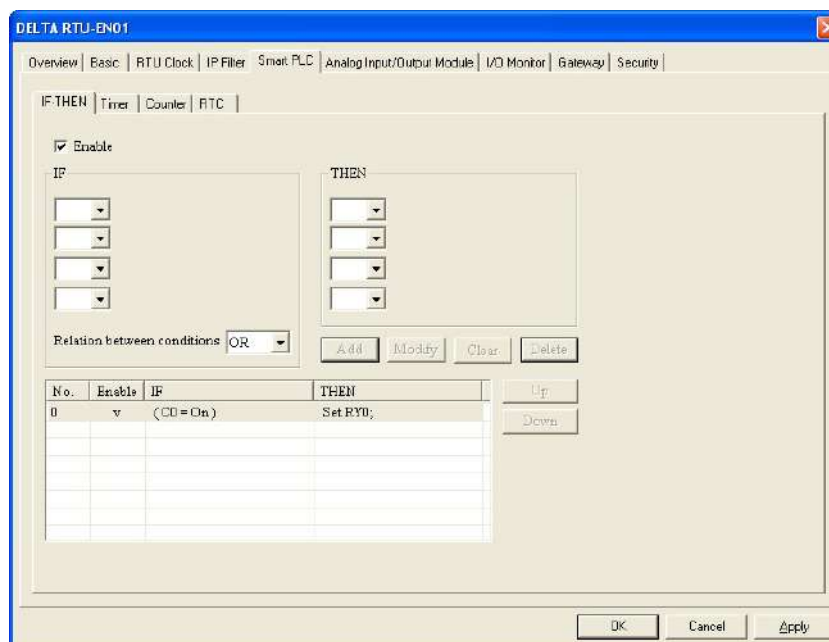



## 7.18 Smart PLC: RTC

Application	Setting up Smart PLC function by DCISoft. RY0 turns On at 08:00 and Off at 09:00 every day.
Steps	(1) Set up the RTC to be On at 08:00 every day and continue to be On for 1 hour. (2) Set up IF-THEN: When the timing reaches the target, RY0 will be On or Off.

1. Open the setup page and switch to “Smart PLC” page. Further switch to the “RTC” page.
2. Check to “Enable” RTC 0 and set Cyclic to “Daily”, Auto-Reset Time to “60 Minute” and enabling time to 08:00:00. Press “Apply” to write the settings into RTU-EN01.

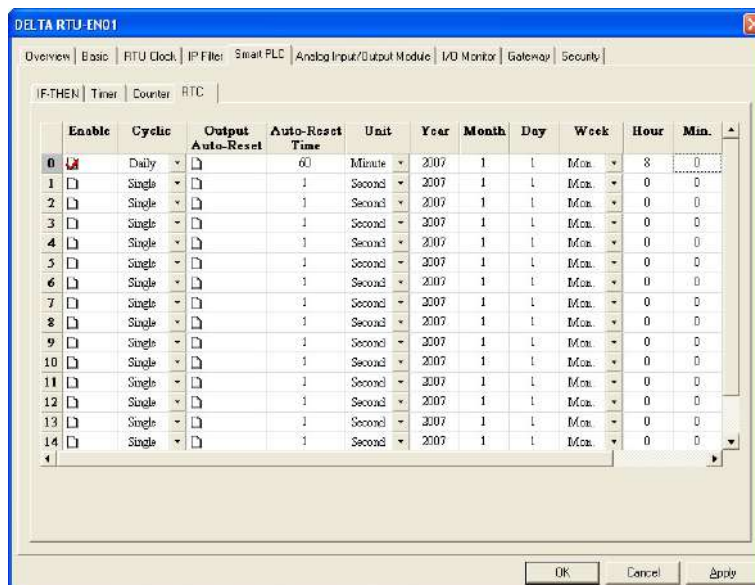
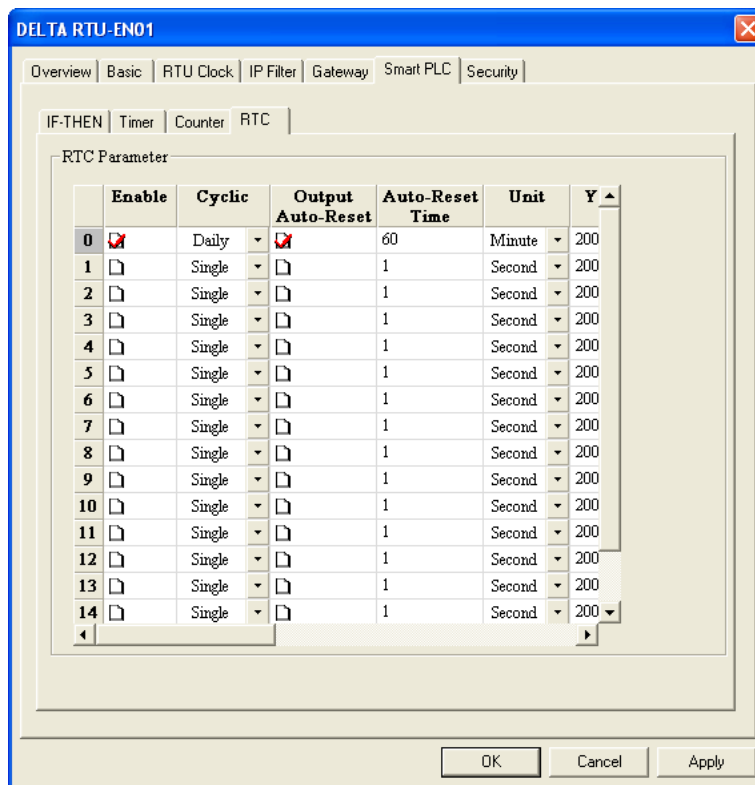

- Switch to "IF-THEN" page. Check the "Enable" box and select "RT0 On" in the IF column and "RY 0 Set" in the THEN column. Press "Add" to add the settings to the table below.
- Check "Enable" and select "RT0 Off" in the IF column and "RY 0 Reset" in the THEN column. Press "Add" to add the settings to the table below and click on "OK" to save the settings into RTU-EN01.

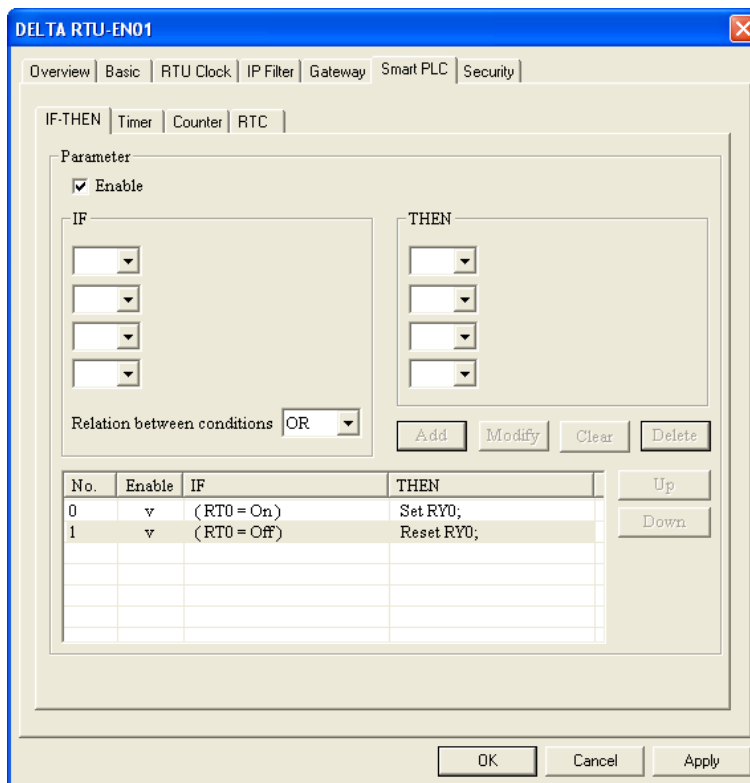

## 7.19 Virtual COM

Application	The virtual COM converts the data sent to RS-232 port into Ethernet. Virtual COM only connects to software supporting serial ports, e.g. Delta WPLSoft, VFDSOft, ASDASoft. See the examples below for how to connect VFD-E series AC motor drive to VFDSOft through by virtual COM.
Steps	<ol style="list-style-type: none"> <li>(1) Select user-defined protocol and set the communication parameters for serial master/slave to the same as the parameters in VFD-E.</li> <li>(2) Set up virtual COM.</li> <li>(3) Open Delta VFDSOft, set up the communication format and establish the connection.</li> </ol>

### 1. Setting up virtual COM

- Select Virtual COM for COM2 mode (RS-485) and set up the same communication parameters as those in VFD-E.



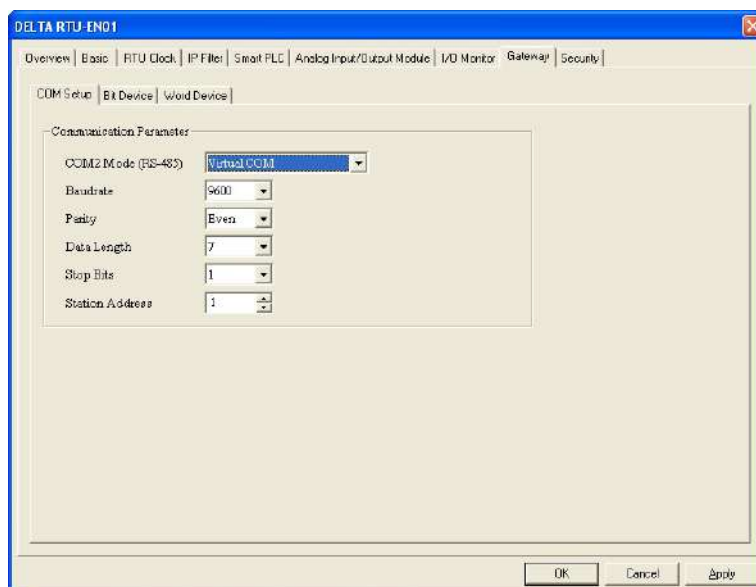

- The default setting for listen port is 20001.
- Open the setup page for Virtual COM.

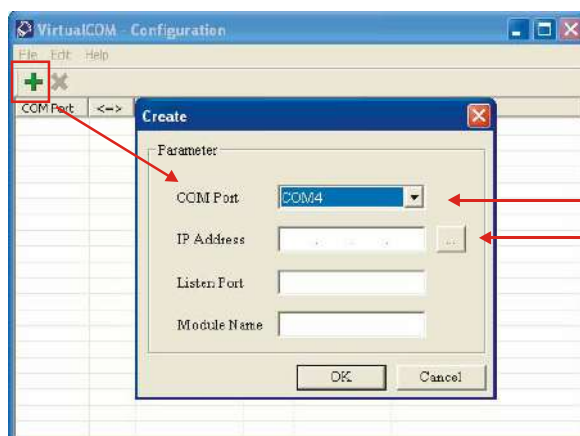
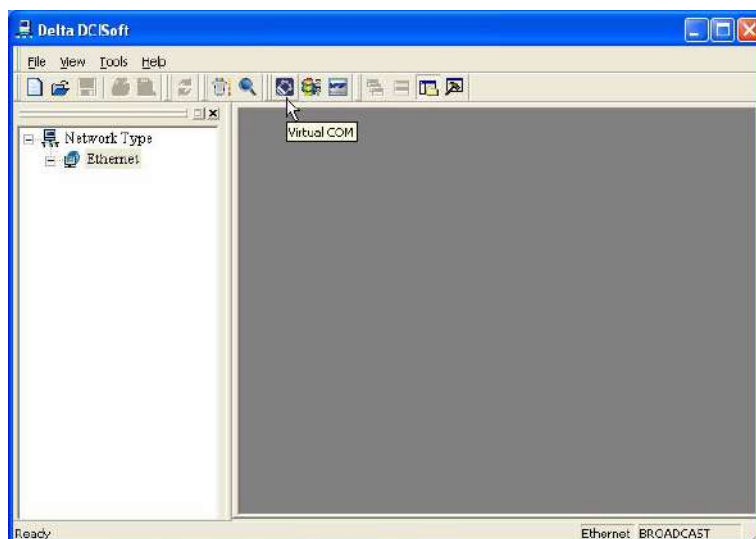

Select COM port  
Search device on network or  
enter IP address

- Press “Search” and you will see all the connected devices on the network.

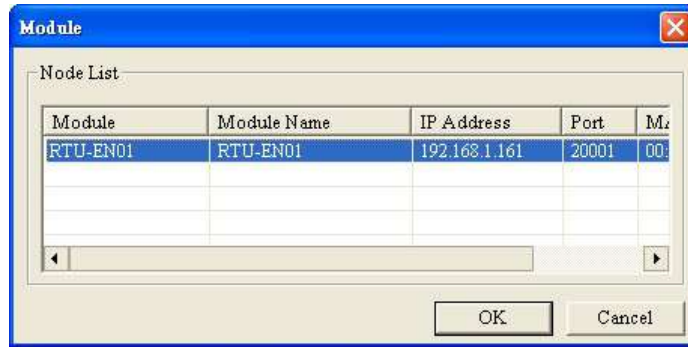

- Select the device and click “OK”. Information on the device will be loaded in automatically. Press “OK” to complete the setup.

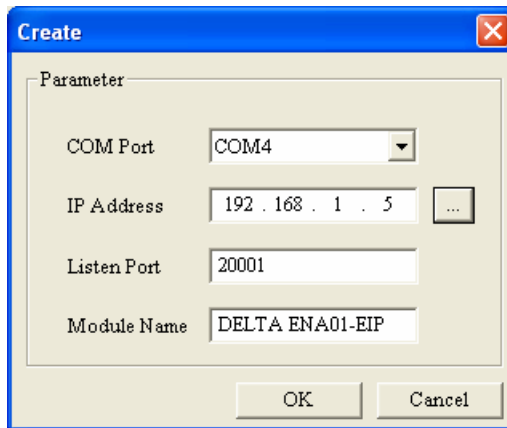

- Once the setup is completed, you will then be able to see the virtual COM just set in “Computer Management”.

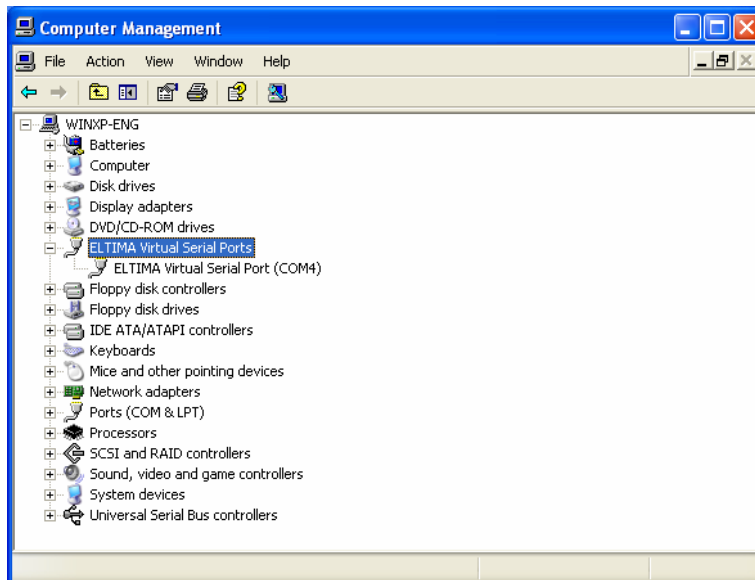

## 2. Use Virtual COM in Delta VFDSOft.

- Open Delta VFDSOft.

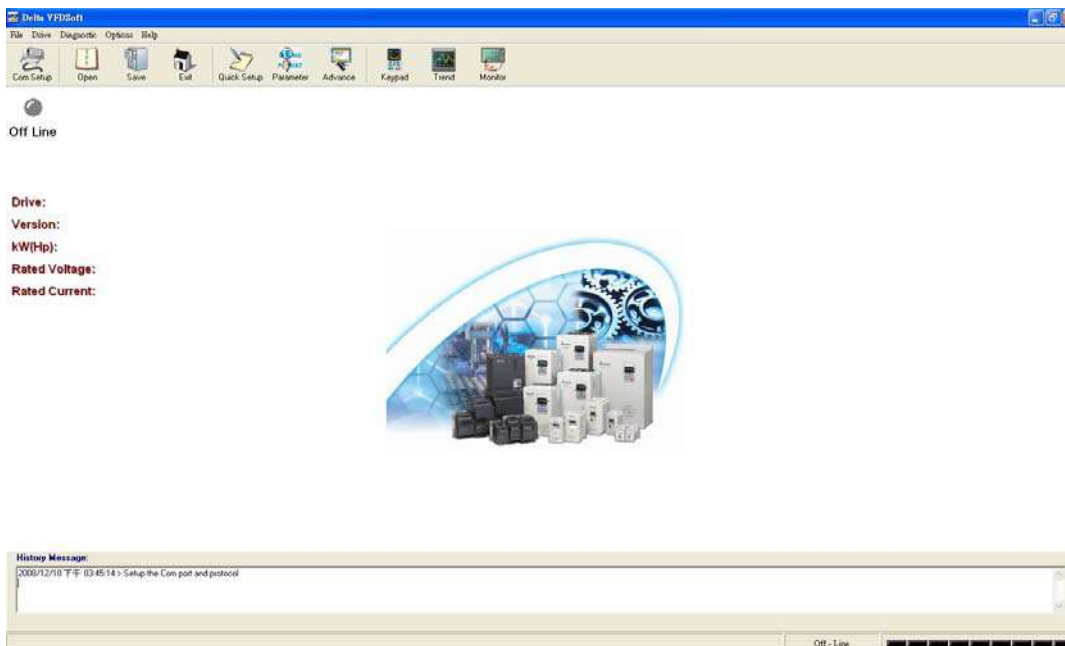

- Set up communication format

Use the Virtual COM (COM2) previously set for the setting of “Com Port”. Next, enter the communication format (38400, 7, E, 1) for VFD-E. Click “Test”. Success flashing in green color means the communication test is successful.

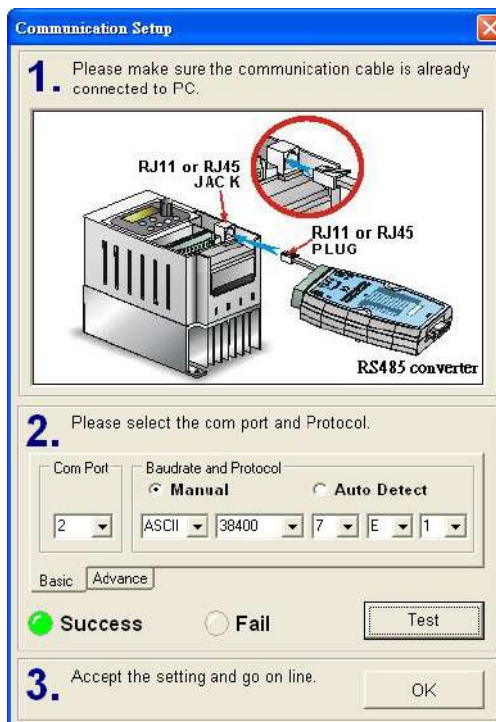

- Click “OK” to establish a connection with VFD-D by VFDSOft.

